

FCC Compliance Statement

Model Name:

Deluxe, Blue, Lite - HD SDI - 4 / 8 / 16 Channel

This device complies with Part 15 of the FCC Rules. Operation is Subject to the following two conditions: (1) this device may not cause harmful interference, and (2) this device must accept any interference received, including interference that may cause undesired operations.

■ WARNING

Unauthorized reproduction of all or part of this manual is strictly prohibited.

The figures in this manual are for illustration purposes only (may differ from the actual product).

The specifications and design of the product are subject to change without prior notice for purposes of quality improvement.

■ CAUTIONS

To get the best use out of the product, be sure to read the cautions before using the product. For safety, please take note of the following.

● Instructions before using the product

- 1 To prevent electric shock when installing, moving, or opening the DVR and peripheral devices, connect and disconnect the cables as instructed. All cables must be connected to grounded power outlets.
- 2 If the product is installed near a power outlet, make sure it can be unplugged easily.
- 3 Do not use the DVR in water or in wet places.
- 4 Keep the plastic packing materials used for the DVR or other peripheral devices out of reach of children (may cause suffocation).

● Installation Environment of the DVR

- 1 Maintain the following conditions: operating temperature of 5°C ~ 40°C; operating humidity of 10% ~ 80%.
- 2 Install the DVR in a safe place that is free from external vibration.
- 3 Install the DVR in a well-ventilated place.
- 4 To protect the hard disk from data loss and breakdown, install the DVR away from magnetic materials.
- 5 When using a rack other than the standard one, use a separate table with sufficient spacing, i.e., 60cm from the floor, 50cm from the ceiling, and 20cm from the side and back walls and other objects.

● Safety Notes on the DVR

- 1 When installing additional boards and HDD, separate the power cable and turn OFF power supplied to the DVR completely.
- 2 Keep the product away from heat-generating devices such as heaters.
- 3 Do not use a damaged power cord.
- 4 To prevent problems due to magnetic interference and electric surge, use only grounded cables and power outlets.
- 5 If the power cord is connected, do not touch the power unit. If the power cord is connected, electric current is still flowing internally even after the switch is turned OFF.
- 6 Do not place a heavy object on top of the product.
- 7 Do not drop a conductive object in the ventilation holes.
- 8 Allot sufficient space for system cabling.
- 9 Use only the parts indicated in the manual. Do not disassemble, repair, or modify the product without permission.
- 10 Incorrect system setup may cause malfunction.
- 11 Shut down the system normally as instructed in the manual.

● Safety Notes on the Lithium Battery

- 1 Replace lithium batteries as instructed to avoid danger.
- 2 Dispose used lithium batteries properly.

【Warning and Caution are indicated as follows.】





 Warning	Possible injury or product damage.
 Caution	Risk of minor injury or product damage.
	Cautions for the usage of the product.
	Information for the usage of the product.

Table of Contents



Chapter 1 . Introduction	8
1 – 1 HD SDI Universal Series Major Features	8
1 – 2 Components	9
1 – 3 Product Introduction	10
Chapter 2 . Installation and connection	11
2 – 1 Names and Features of Each Part	11
2 - 1 - 1 Deluxe-16CH Rear Panel	11
2 - 1 - 1 BLUE-08CH Rear	11
2 - 1 - 2 BLUE-16CH Rear	11
2 - 1 - 3 LITE-04CH Rear	11
2 - 1 - 4 LITE-08CH Rear	12
2 - 1 - 5 LITE-16CH Rear	12
2 – 2 Installation and Connection	12
2 - 2 - 1 Basic Connection	15
2 – 3 Connection of Other Devices	15
Chapter 3 . Operation and Setup Tools	17
3 – 1 Deluxe Series Front Panel Button	17
3 – 2 Blue Series Front Panel Button	18
3 – 3 Lite Series Front Panel Button	18
3 – 4 Deluxe/ Blue series Remote Controller	19
3 – 5 Lite series Remote Controller	20
3 – 6 Mouse	20
3 – 7 Jog/Shuttle	21
Chapter 4 . DVR Operation Setup	22
4 – 1 Deluxe Series Storage Installation	22
4 – 2 Blue Series Storage Installation	24
4 – 3 Lite Series Storage Installation	25
4 – 4 Power ON	25
4 – 5 Storage Setup	26
4 – 6 Recording Setup	26
4 – 7 Date/Time Setup	26
4 – 8 Camera / TV Setup	27
4 – 9 Display Setting and Other Setup	27
4 – 1 0 External Device Setup	27
4 – 1 1 Search	27
4 – 1 2 Backup	27
4 – 1 3 DVR Info	27
Chapter 5 . System Operation	28
5 – 1 Real Time Monitoring Mode and Icon	28
5 – 2 System Login	29
5 - 2 - 1 User Account and Authorization	29
5 - 2 - 2 Login	29
5 - 2 - 3 Logout	30
5 – 3 Monitoring	30
5 - 3 - 1 Screen Division and Auto Sequence	30
5 - 3 - 2 Spot	31
5 - 3 - 3 Menu in Monitoring Mode	32
5 - 3 - 4 Zoom	32
5 - 3 - 5 Screen Control by using PTZ	33
5 – 4 System Information and Screen Setup Change	34

5-4-1	System Information	34
5-4-2	Screen Brightness/Contrast/Color/Saturation/Sharpen/Camera Adjustment	35
5-4-3	Display Setting	35
5-4-4	Screen Saver	36
5-5	Control	36
5-6	Search	37
5-6-1	Search Mode	37
5-6-2	Playback Menu	37
5-7	Calendar Search	37
5-7-1	Search Mode	37
5-7-2	Year/Month/Day Selection	38
5-7-3	Time Index	38
5-7-4	Event	38
5-7-5	Multi-Channel Search	38
5-7-6	Multi-Time Search	38
5-7-7	Multi-Day Search	39
5-7-8	List All	39
5-8	POS Search	39
5-8-1	POS Search Mode	39
5-8-2	Year/Month/Day/Text/Time Selection	39
5-8-3	Search / Playback	40
5-9	Playback	40
5-9-1	Playback and Playback Speed Control	41
5-9-2	Smart Search	42
5-9-3	POS Search	43
5-9-4	Calendar Search	43
5-9-5	MULTI TIME	43
5-9-6	MULTI DAY	43
5-9-7	MULTI CHANNEL	43
5-9-8	Panorama Play	43
5-9-9	Event	43
5-9-1 0	Backup	44
5-9-1 1	Screen Mode	44
5-1 0	Log Viewer	44
5-1 0-1	Log Type	44
5-1 0-2	System Log Viewer	45
5-1 1	Recording	45
5-1 1-1	Recording Types	45
5-1 1-2	Recording Setup	45
5-1 1-3	Recording Status View	46
5-1 2	Backup	46
5-1 2-1	Backup in The Real-Time Monitoring Mode	46
5-1 2-2	Backup in Search Mode	46
5-1 2-3	Backup in Log Mode	46
5-1 2-4	Backup in Playback Mode	46
5-1 2-5	Common Backup Procedure	47
5-1 3	Setup Backup	47
5-1 4	Log Backup	48
5-1 5	Capture	49
Chapter 6 . Setup	50	
6-1	Time	50
6-1-1	Time Sync	50
6-1-2	Date and Time	50
6-1-3	Standard Time Zone	51
6-1-4	Auto Reboot	51
6-2	Camera	52

6-2-1	Camera	52
6-2-2	PTZ	52
6-2-3	POS	52
6-2-4	Event Source	52
6-2-5	Relay	53
6-3	Recording	53
6-3-1	Schedule Selection (Schedule1 ~ Schedule4)	53
6-3-2	Event	53
6-3-3	Recording	54
6-3-4	Alarm	54
6-3-5	Duration	54
6-3-6	Log	54
6-4	Schedule	55
6-4-1	Schedule Setup	55
6-5	Storage	56
6-5-1	Max. Recording Days	56
6-5-2	HDD Overwrite	56
6-5-3	Local Storage Management	56
6-6	Network	58
6-6-1	Ethernet	58
6-6-2	DDNS	58
6-6-3	Port	59
6-6-4	E-mail	59
6-6-5	Bandwidth	61
6-7	System	61
6-7-1	DVR Name	62
6-7-2	ID for Remote Controller	62
6-7-3	ID For Keyboard Controller	62
6-7-4	User Registration	62
6-7-5	Admin. Password	62
6-7-6	Upgrade	63
6-7-7	Factory Default	64
6-7-8	Console / POS Port	64
6-7-9	Alarm	64
6-7-1 0	Alarm Duration	64
6-7-1 1	Menu Time Out	64
6-7-1 2	Language	64
	A/P/P/E/N/D/I/X	65
	Recommended PTZ Camera Protocol	65



Figure List

[Figure 2-1. DELUXE-16CH Basic Connection and Device Connection]	13
[Figure 2-2. BLUE-08CH Basic Connection and Device Connection].....	13
[Figure 2-3. BLUE-16CH Basic Connection and Device Connection].....	13
[Figure 2-4. LITE-04CH Basic Connection and Device Connection]	14
[Figure 2-5. LITE-08CH Basic Connection and Device Connection]	14
[Figure 2-6. LITE-16CH Basic Connection and Device Connection]	14
[Figure 2-7. Terminal Block and Description].....	16
[Figure 4-8. Menu Window]	25
[Figure 5-9. Recording Status Window].....	28
[Figure 5-10. Login Window].....	29
[Figure 5-11. HD-SDI Universal model 16CH Channel Mode]	30
[Figure 5-12. HD-SDI Universal model 8CH Channel Mode].....	30
[Figure 5-13. HD-SDI Universal model 4CH Channel Mode].....	30
[Figure 5-14. Spot]	32
[Figure 5-15. Zoom Control Screen]	32
[Figure 5-16. PTZ Setup]	33
[Figure 5-17. PTZ Control]	33
[Figure 5-18. PTZ Control Mini/Full]	34
[Figure 5-19. Product Information Window]	34
[Figure 5-20. Screen Setup Window]	35
[Figure 5-21. Display Setting Window]	35
[Figure 5-22. Display Setting Window]	36
[Figure 5-23. Audio]	36
[Figure 5-24 . Relay].....	36
[Figure 5-25. Text].....	36
[Figure 5-26. Playback Menu]	37
[Figure 5-27. Search Window].....	38
[Figure 5-28. Time Index].....	39
[Figure 5-29. POS Search].....	40
[Figure 5-30. Playback Screen]	40
[Figure 5-31. Playback Status and Control Window]	41
[Figure 5-32. Playback Menu]	42
[Figure 5-33. Smart Search Area Designation]	42
[Figure 5-34. Smart Search Motion Detection Window]	43
[Figure 5-35. Panorama Playback].....	43
[Figure 5-36. Display Mode]	44
[Figure 5-37. Log View]	44
[Figure 5-38 . Move to the log list of the certain time zone in Log View]	45
[Figure 5-39. Backup Window]	47
[Figure 5-40. Backup and Sub-menu Setup Backup]	48
[Figure 5-41. Setup Upgrade]	48
[Figure 5-42. Log Backup].....	48
[Figure 6-43. Setup / Time Menu]	50
[Figure 6-44. Setup / Auto Reboot Menu]	51
[Figure 6-45. Setup / Camera Menu]	52
[Figure 6-46. Motion Area Setup].....	53
[Figure 6-47. Setup / Recording]	53
[Figure 6-48. Schedule Window].....	55
[Figure 6-49. Storage Window (Local)].....	56
[Figure 6-50. Setup Network Window]	58
[Figure 6-51. Network Port Window].....	59

[Figure 6-52. Setup Network Ethernet Window]	60
[Figure 6-53. Setup Network E-Mail Window1]	60
[Figure 6-54. Setup Network E-Mail Window2]	60
[Figure 6-55. System Setup Window]	61
[Figure 6-56. Firmware Upgrade Progressing Window]	63

Chapter 1 . Introduction

1-1 HD SDI Universal Series Major Features

Line Up		HD SDI Universal DVR		
Series		Deluxe	Blue	Lite
Model Name		Deluxe 16ch	Blue-16ch/8ch	Lite-4ch/8ch/16ch
System	OS	Embedded Linux - Built in flash memory		
	Access	Front button, Mouse, Remote Controller, Network, Key controller		
	Hexaplex	Live monitoring, Recording, Playback, Backup, Network, Setup		
	Upgrade	USB2.0 Memory stick, Network		
Video	System	NTSC / PAL - Config switch		
	Input	16, 8BNC		
	Output	1 HDMI, 1 VGA, 1 BNC		
	Loop	N/A		
	Spot	★ 1 BNC - Multi-channel (16/9/4/1)		
Audio	Input	16, 8, 4 RCA		
	Output	HDMI, RCA		
Video Recording	Compression	H.264		
	Speed	Max. 1080P Real-time(max. 30fps/ch)		
	Resolution	★1080P(1920x1080), 720P(1280x720), 960H (960x480/576)		
	Event	Sensor, Motion, Audio, Text		
	Bit Rate	Max 8Mbps/ch, Adjustable		
Audio Recording	Compression	G.711U		
	Audio Sampling Rate	16KHz		
Network	Interface	Ethernet 10/100/1G		
	Compression	H.264		
	Speed	Max. 720P 8fps/ch		
	Resolution	Max. 720P		
Backup	Interface	USB2.0, DVD, Network		USB2.0, Network
	Format	Video clip (Backup viewer), JPEG Still Image Log list, Setup data		

Line Up		HD SDI Universal DVR		
Series		Deluxe	Blue	Lite
Model Name		Deluxe 16ch	Blue-16ch/8ch	Lite-4ch/8ch/16ch
Alarm	Pre/Post-Alarm	5sec / 5sec~5min		
	Alarm Action	E-mail, Channel Popup, Buzzer, Relay, PTZ Preset, Spot, Remote VMS, Front LED		
	Input / Output	4/1, 4/1, 4/1 - NC/NO/EOL		
Display	HDMI	★ Full HD, XGA		
	VGA	Full HD, XGA		
	TV	SDTV(720x480/576)		
	Mode	16/9/4/1/SEQ - LIVE, 16/9/4/1 - P.B		
External Interface	PTZ / Keyboard	★ 2 RS485 - Terminal Block		
	ATM / POS	★ RS232C - Terminal Block		
Storage	Primary	6 HDD	3 HDD	2 HDD or 1 HDD + 1 eSATA
	External	2 eSATA	1 eSATA	
	ODD	1 DVD		N/A
Features	Jog-shuttle	Yes	N/A	
	H/W RAID	★ RAID1, 5 Options	★ RAID1,5 Options	N/A
	EOL Register(10K)	★ 4Ch		
	Coaxitron	★ Yes		
	DDNS, DHCP, UPNP	Yes		
	VMS, RMS	Windows		
	Smart Phone (3G)	Android, iPhone, iPad		
Mac Viewer	★ Apple Mac OS			
General	Power Supply	90~250V, 50/60Hz	12V/5A - Level 5	
	Consumption	80Watts	60Watts	
	Dimension	440 x 88 x 430 mm	430 x 86 x 270 mm	340 x 59 x 300 mm

1-2 Components

After unpacking the product, check whether following accessories are included.

- Remote Controller
- CD (VMS, VMS Manual, User Manual)
- AAA 1.5V Batteries 2ea
- Quick Service Guide
- Rack Mount Handle (Only for Deluxe, Blue serie)
- Power code (Deluxe Models)

1 - 3 Product Introduction

- 1080P/720P/960H real-time recording
- 16/8/4 Ch audio recording
- 16/8 CH spot output
- Various video output port (HDMI, VGA, BNC)
- Various video output mode (Full HD, XGA, SDTV)
- 6 HDD bay (Deluxe Model)
- 3 HDD bay (Blue-16ch, Blue -8ch)
- 2 HDD bay (Lite-16ch, Lite -8ch, Lite -4ch)
- Jog-shuttle(Deluxe Model)
- 1Ch POS/ATM interface
- Pre-alarm recording
- Auto e-mailing notification max. 5 users
- Privacy zone mask
- Covert channel
- Digital single/multi-zoom
- Smart search
- Text detection/search
- Multi-time/day, Index (event) search/playback
- Panorama playback
- Still image capture Full HD resolution
- Firmware upgrade at a remote PC site
- Remote setup, backup, relay control
- Screen Saver
- USB/DVD backup with self-executable player (backup player)
- Web monitoring in PC (Built in web server)
- Smart Phone viewer (Android, iOS)
- Mobile web viewer (3G viewer)
- NTP, DST, DDNS, DHCP

Chapter 2 . Installation and connection

2-1 Names and Features of Each Part

2-1-1 Deluxe-16CH Rear Panel

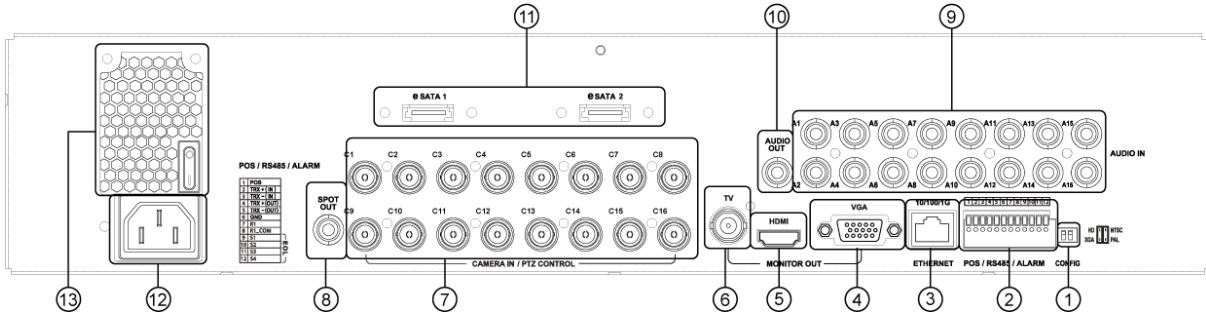

2-1-2 BLUE-08CH Rear

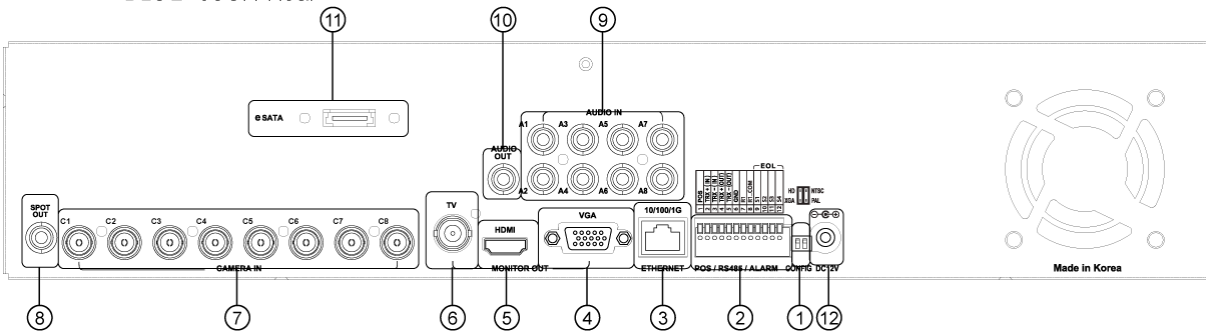

2-1-3 BLUE-16CH Rear

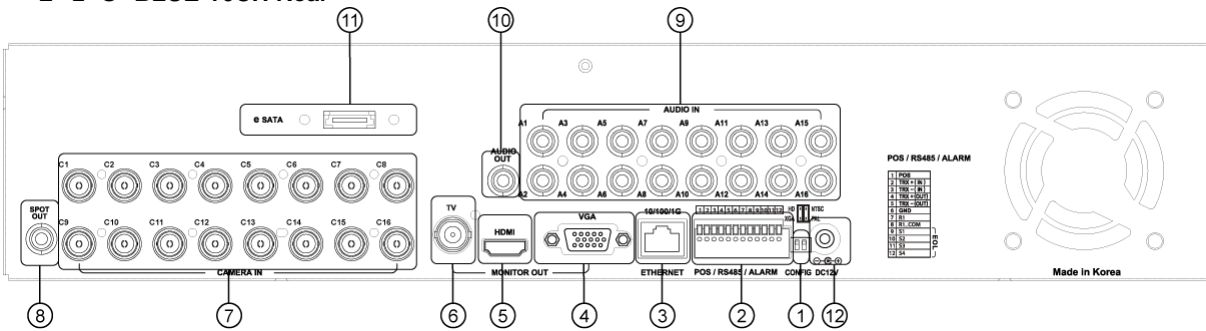

2-1-4 LITE-04CH Rear

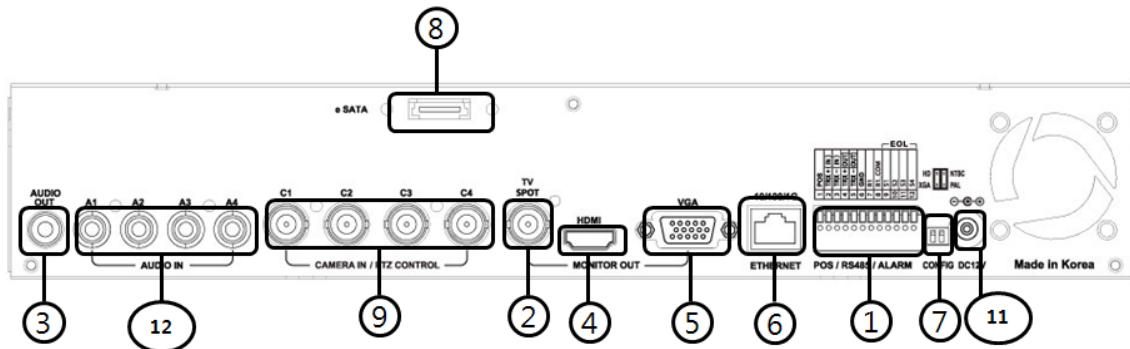

2-1-5 LITE-08CH Rear

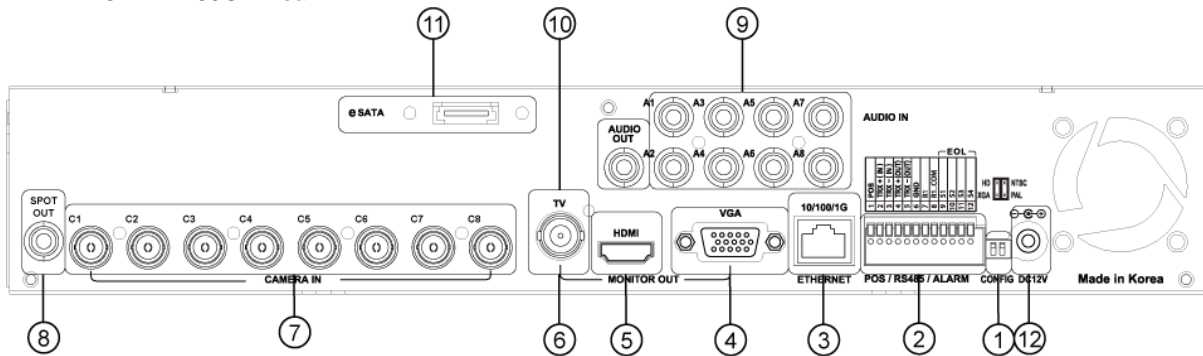

2-1-6 LITE-16CH Rear

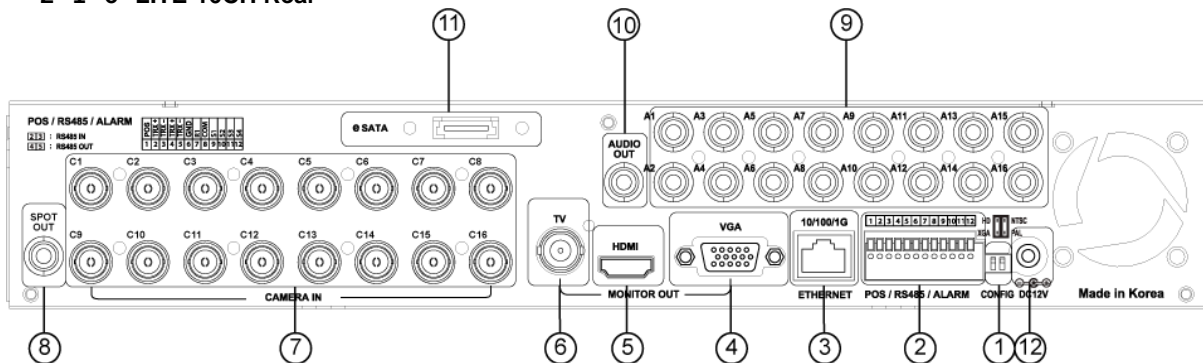

No.	Name	Feature	Type
1	CONFIG	NTSC/PAL HD / XGA	DIP SW, 2-pin
2	Terminal Block	RS-485 / SENSOR IN / RELAY OUT / POS	Terminal Block
3	Ethernet	Cable Modem, Ethernet 10/100 Base-T, Network Connection	RJ-45
4	VGA-OUT	VGA Monitor or LCD Monitor Connection	D-SUB 15P
5	HDMI	HDMI Output	HDMI type-C
6	TV	CVBS Output	BNC
7	CAMERA IN	Video Camera Connection	BNC
8	SPOT	CCTV monitor connection to output images of the channel generating an event signal	BNC
9	AUDIO IN	Audio Input Connection	RCA
10	AUDIO OUT	Audio Output Connection(Line Only Output)	RCA
11	e-SATA	External SATA	USB Type A, e-SATA
12	Power	90 ~ 250V, 50/60Hz, 80 Watts (H-model series)	AC Inlet
13	Ventilating Opening		Power supply Fan

2-2 Installation and Connection

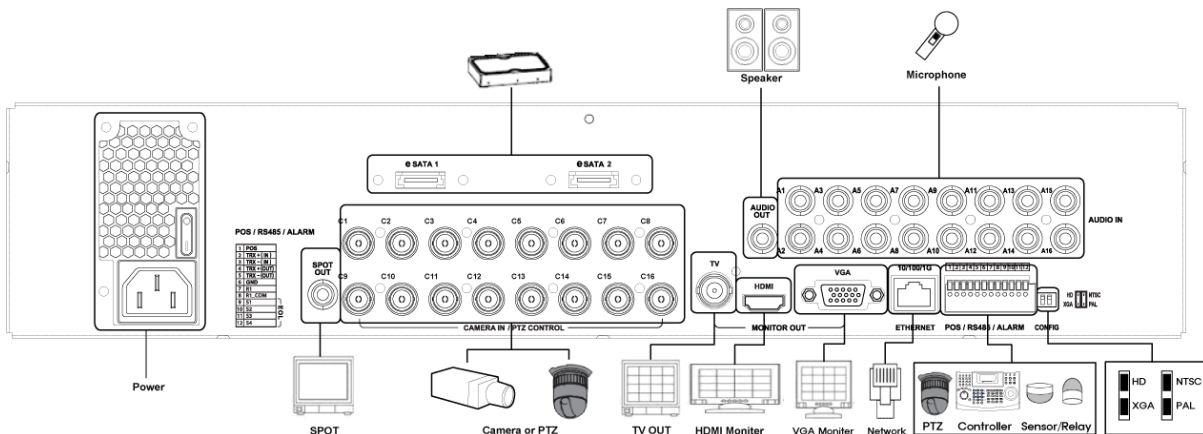

[Figure 2-1. DELUXE-16CH Basic Connection and Device Connection]

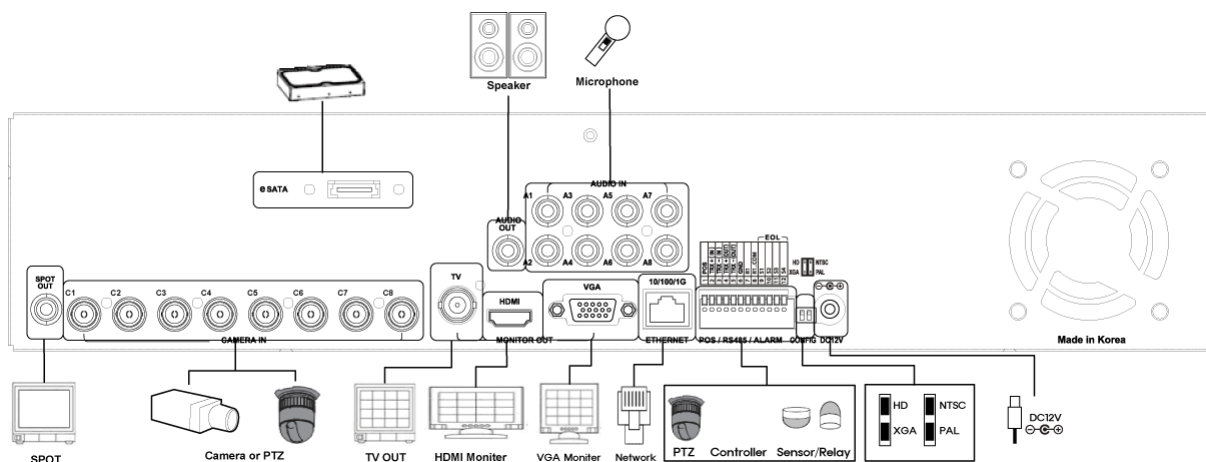

[Figure 2-2. BLUE-08CH Basic Connection and Device Connection]

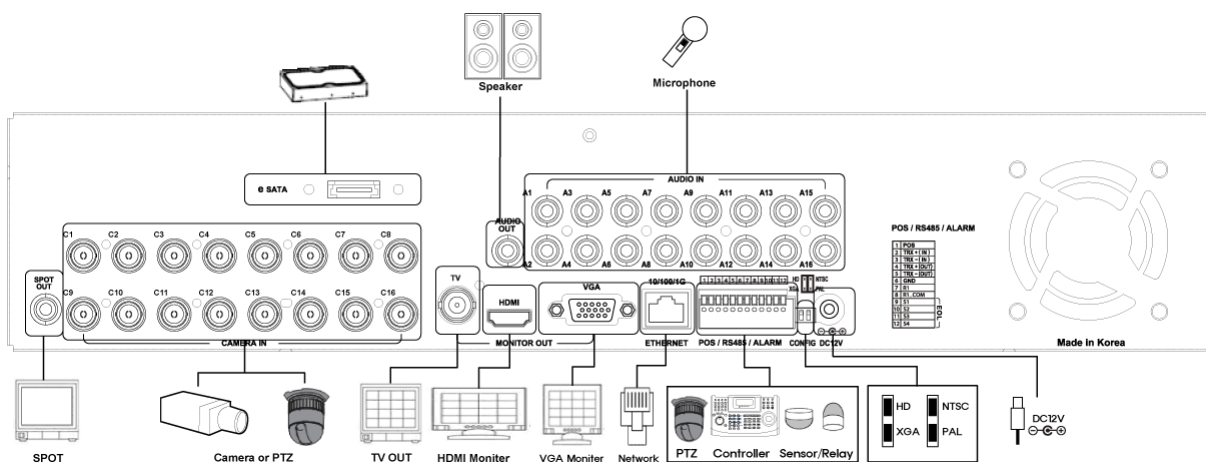

[Figure 2-3. BLUE-16CH Basic Connection and Device Connection]

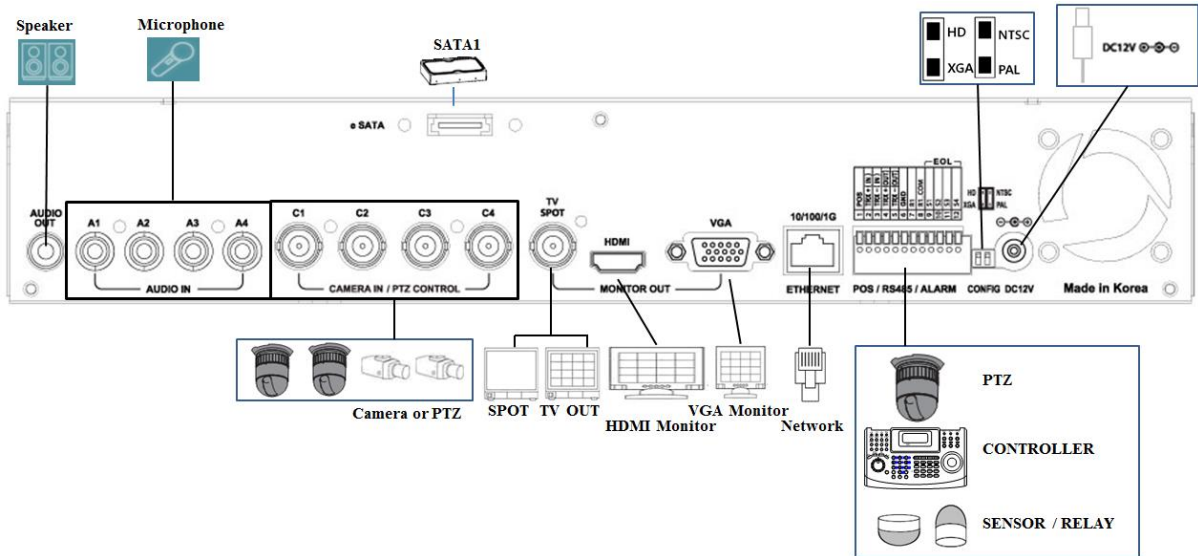

[Figure 2-4. LITE-04CH Basic Connection and Device Connection]

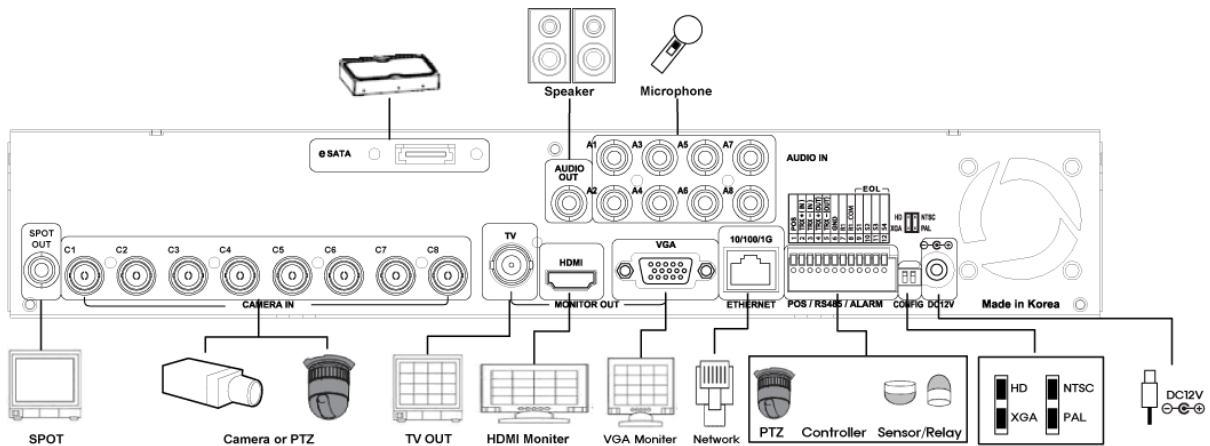

[Figure 2-5. LITE-08CH Basic Connection and Device Connection]

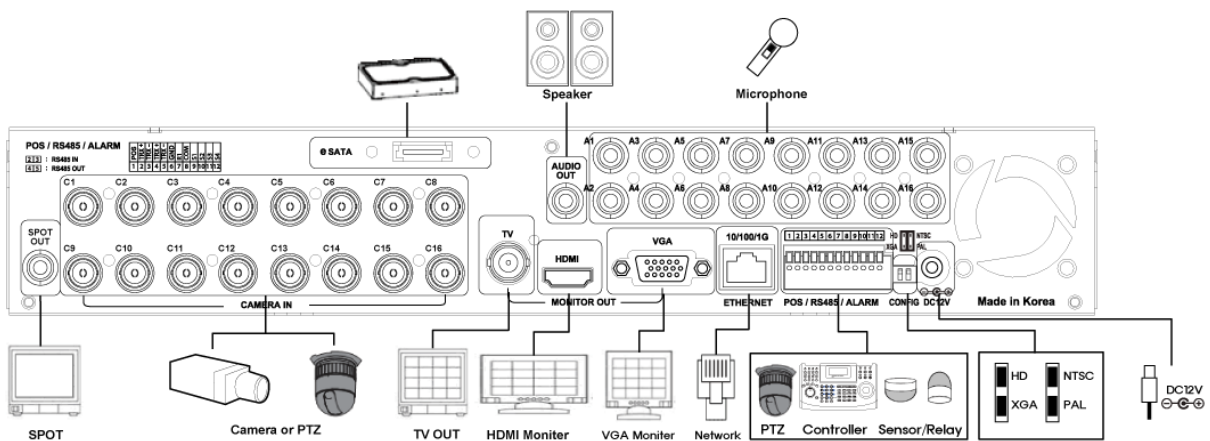

[Figure 2-6. LITE-16CH Basic Connection and Device Connection]

2-2-1 Basic Connection

※ By referring to above [Figure 2-1], make a connection accordingly.

Connection Order	Connection Device	DVR Terminal
1	CCTV Camera	Rear Panel Video IN
2	CCTV Audio	Rear Panel Audio IN / OUT
2	CONFIG SWITCH Setup	Rear Panel Left 2ea Switch (Refer to below; CONFIG SWITCH Setup)
3	CCTV Monitor	Rear Panel TV / SPOT
4	VGA Monitor / LCD Monitor	Rear Panel VGA-OUT
5	HDMI Monitor	Rear Panel HDMI
6	Loop	Rear Panel Loop

■ CONFIG SWITCH Setup

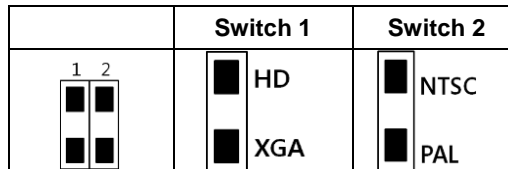

2-3 Connection of Other Devices

	HD SDI universal series has differences in feature as described below. Be cautious
---	---

Item	DELUXE-16	BLUE-04	BLUE-08	BLUE-16	LITE-04	LITE-08	LITE-16
Audio	16	4	8	16	4	8	16
Sensor	4	4	4	4	4	4	4
Relay	1	1	1	1	1	1	1
POS	1	1	1	1	1	1	1

Connect the PTZ controller cable, audio input/output, network, and sensors as shown below.

	Connecting Device	DVR Terminal
1	SPOT Monitor(CCTV Monitor)	Rear Panel SPOT
2	Mike / Speaker	Rear Panel Audio Input / Audio Output
3	LAN Cable	Rear Panel Ethernet
4	PTZ Camera	Rear Panel Terminal Block
5	Sensor / Relay / POS	Rear Panel Terminal Block
6	Keyboard controller	Rear Panel Terminal Block

1) SPOT Monitor

Connect Spot Monitor to the rear SPOT terminal.
HD SDI universal series supports 1ea SPOT terminals

2) Audio Input/Output

DELUXE-16CH supports 16ea audio inputs.
BLUE-16CH supports 16ea audio inputs and BLUE-08CH supports 8ea audio inputs.
LITE-04 supports 4ea audio inputs, LITE-08 supports 8ea audio inputs & LITE-16 supports 16ea audio inputs.

3) Terminal Block

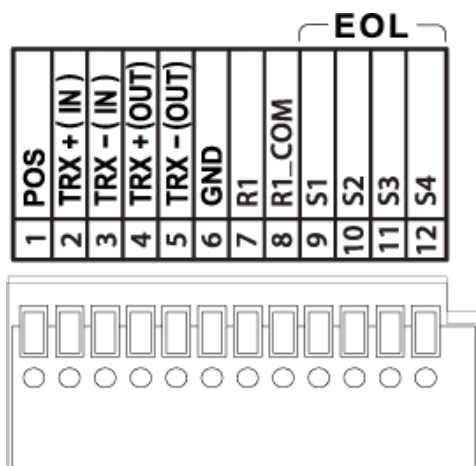

[Figure 2-7. Terminal Block and Description]

The terminal blocks in the rear of the product are for the connection of PTZ / Sensor / Relay / POS Connection. The number of the terminal block may be different depending on the model.

① PTZ Camera/Keyboard Controller

Connect PTZ control cable; TRX+, TRX- and GND to Terminal Block(TB1);No.4 TRXD+, No.5 TRXD- and No.10 GND in the rear of DVR. You may refer to APPENDIX for supported PTZ cameras in this manual. Keyboard controller has the same connection as PTZ camera.



PTZ Camera may not be working properly if GND is not connected.

Caution

② Sensor/Relay /POS

Connect Sensor/Relay/POS to the terminal block directly depending on the model.



Sensor and Relay Type

NC(Normal Close) : Normally closed; opens when a signal is received

NO(Normal Open) : Normally open; closes when a signal is received

(1) Sensor Connection

- ① Connect the sensor to the terminal block S1 ~ S16 depending on the model.
- ② Each input terminal is connected relatively with the channel number.

(2) Relay Connection

- ③ Relay the output signal to external devices such as Alarm and Siren.
- ④ Connect the relay to R1/R2/R3/R4 terminal block depending on the model

(3) POS Connection

- ⑤ Connect the POS device.
- ⑥ Connect the POS to Terminal Block POS.



The external alarm device may require the power supply depending on its type. Be cautious.

Caution

Chapter 3 . Operation and Setup Tools

HD SDI Universal Series can be controlled easily by using the front panel buttons, front panel, remote controller, jogshuttle and mouse.

3 -1 Deluxe Series Front Panel Button

No.	Name	Function
1	LABEL	Brand Name and Model Name
2	LED DISPLAY	HDD and System Power and Status Indication LED
3	Number Button	Channel Selection or Number Input
4	MOVE & DISPLAY & Select	Move from one category to another or change to the display mode or select
5	MENU	Various Modes
6	JOG & SHUTTLE	Speed in Playback Mode / Play Direction / Frame Play
7	POWER	Turn the system power ON or OFF
8	USB Port	Connection port to the USB mouse and USB memory stick
9	ESC	Exit the current menu or move to the upper menu
10	SPOT	Spot Control
	PTZ	PTZ Pan/Tilt/Zoom Control
	CAPTURE	Capture the displaying image into USB
	BACKUP	Save the recorded image at other media.
	SEARCH	Search the recorded Image.
11	Reverse Play / Fast Reverse RELAY	Backward Playback/Rewind (in the Playback Mode) Relay Control (in the Monitoring Mode)
	Reverse Frame by Frame STATUS	Backward Playback Frame by Frame (in the Playback Mode) View System Configuration (in the Monitoring Mode).
	Pause LOCK	Pause (in the Playback Mode) Lock (in the Monitoring Mode)
	Forward Frame by Frame LOG	Playback Frame by Frame (in the Playback Mode) System Log View(in the Monitoring Mode)
	Forward Play / Fast Forward PLAY	Playback/Fast Forward (in the Playback Mode) Play back (in the Monitoring Mode)

3-2 Blue Series Front Panel Button

No	Name	Feature
1	LABEL	Brand Name and Model Name
2	ODD	CD-RW and DVD-RW
3	Eject	CD and DVD Media
4	Reverse Play / Fast Reverse & RELAY	Backward Playback/Rewind (in Playback mode) Relay Control (in Monitoring mode)
5	Reverse Frame by Frame & STATUS	Backward Playback Frame by Frame (in Playback mode) View System Configuration (in Monitoring mode).
6	Pause & LOCK	Pause (in Playback mode) Lock (in Monitoring mode)
7	Forward Frame by Frame & LOG	Playback Frame by Frame (in Playback mode) System Log View(in Monitoring mode)
8	Forward Play / Fast Forward & PLAY	Playback/Fast Forward (in Playback mode) Play back (in Monitoring mode)
9	ESC	Exit the current menu or selects the upper menu.
10	USB Port	Connection port to the USB mouse and USB memory stick
11	POWER	Turn the system power ON or OFF.
12	POWER LED	Power LED On/Off
13	MOVE & DISPLAY & Select	Moves from one category to another or changes the display mode.
14	MENU	Various Modes
15	SEARCH	Search Recorded Images.
16	BACKUP	Save recorded images at other media.
17	CAPTURE	Capture a playing image into USB.
18	PTZ	Change Pan/Tilt/Zoom Mode.
19	SPOT	SPOT Control
20	NUMBER	Channel Selection and Number Input
21	ERROR LED	Blue LED turned on upon fan defect or recording interruption.
22	ALARM LED	Blue LED turned on upon the occurrence of event or motion.
23	NETWORK LED	Blue LED turned ON during remote access.
24	RECORD LED	Blue LED turned on upon HDD operation.

3-3 Lite Series Front Panel Button

No.	Name	Feature
1	POWER	Power On/Off
2	MOVE & DISPLAY	Move from one category to another or change the display mode
3	ESC	Exit the current menu or selects the upper menu
4	MENU	Various Modes
5	MODE	Menu for display mode
6	PLAY	Playback/Fast Forward (in Playback mode)
7	Frame by Frame	Playback Frame by Frame (in Playback mode)
8	PAUSE	Pause (in Playback mode)
9	Reverse Frame by Frame	Backward Playback Frame by Frame (in Playback mode)
10	Reverse Play	Backward Playback/Rewind (in Playback mode)
11	IR Sensor	Remote controller input sensor
12	POWER LED	LED indicating Power On/Off
13	RECORD LED	Green LED turned on upon HDD operation
14	LABEL	Brand Name and Model Name
15	USB	[Side] USB Mouse, USB Memory Stick Connection Port

3 - 4 Deluxe/ Blue series Remote Controller



A) Basic Control Button

	POWER	Turn the system power ON or OFF.
	RECORD	Record all channels or stops recording all channels.
	NUMBER	Input of numeric data.
	ID	Set up the remote controller ID.

B) System Operation and Setup Button

	MENU	Data, Schedule, System Set up
	ESC	Exit the current menu or Move to the upper menu.
	SEARCH	Search recorded images.
	SELECT	Select the category or execute automatic screen conversion.
	COPY	Copy recorded videos.
	PTZ	Shift to the PTZ camera control mode.
	MOVE	Move from one category to another or change to the display mode.
	UP/ DOWN	Log Page Up/Down

C) Search Button (Playback Mode)

	Play / Fast Forward	Play/Fast-forward
	Frame by Frame	Play forward frame by frame
	Pause	Pause
	Reverse Frame by Frame	Reverse play frame by frame
	Reverse Play / Fast Reverse	Reverse play/ Rewind







D) Buttons for Other Features (Monitoring Mode)

	PLAY	Play the recorded images.
	LOG	View the system log list.
	LOCK	Lock the system
	STATUS	View system information and changes the display setup.
	RELAY	View the relay status and manual operation.







	※ Setting up the remote controller ID
	Example) When the remote controller ID is set to 1 Press the {ID} button, enter {0} and {1}, and press the {ID} button again. To control all DVRs with the different ID, set the remote controller ID to 999.

3 - 5 Lite series Remote Controller



	POWER	Turn the system power ON or OFF.
	MODE	
	FULL	1CH Mode
	QUAD	4CH Mode
	9 SPLIT	9CH Mode
	16 SPLIT	16CH Mode
	SEQ.	Sequence Mode ON/OFF

B) System Operation and Setup Button

	MENU	Data, Schedule, System Set up
	ESC	Exit the current menu or Move to the upper menu.
	PREV	Move back (Reverse)
	PAUSE	Pause
	FORWARD	Move forward
	BACKWARD	Playback
	PLAY	Play





3 - 6 Mouse

The mouse pointer as shown below appears if a mouse is connected to the USB terminal at the front panel.

	Mouse Control functions are shown below.	
	Click on the right button	Monitoring Mode / Move from Play Mode to Monitoring Menu / Pop up or remove Play Menu. Show sub-folder of the certain Menu window.
	Click on the left button	Select Menu.
	Double click on the left button	Select Menu.
	Click the left button and drag	Move a certain window.

3 - 7 Jog/Shuttle

In the playback mode, control the play direction, speed and frame.

Front	Side
<p style="text-align: center;">Speed and Direction Control</p>  <p style="text-align: center;">Frame Control</p>	
	<p>※ Play Direction Control This is available in the playback mode. Turning the jog right/left plays forward/reverse frame by frame.</p>
	<p>※ Speed and Direction Control This is available in the playback mode. Turning the jog right/left plays forward/reverse x1/x2/x4x30.</p>

Chapter 4 . DVR Operation Setup

4-1 Deluxe Series Storage Installation

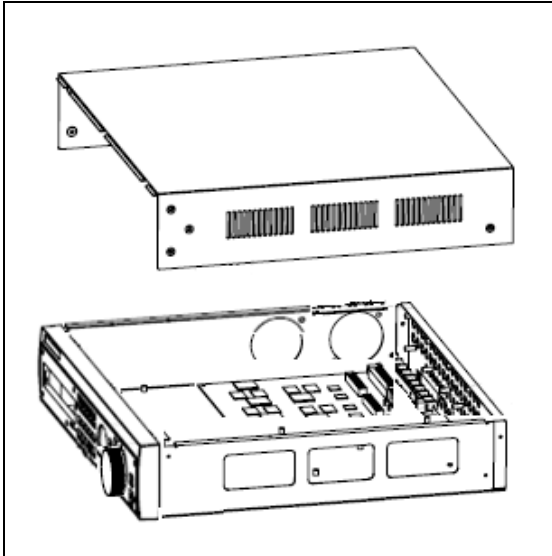

※ Step 1

1) Using a screw driver, unscrew and take off the top case of the product.



Caution

1) Normal termination of the system and fully unplugged power code are required before conducting HDD installation.
2) After installing HDD, Do not connect to power supply with the top case opened. The top case must be covered before usage.

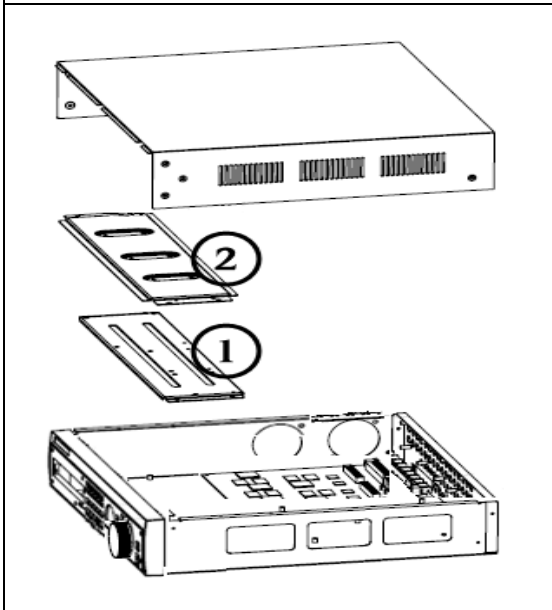

※ Step 2

2) Using a screw driver, unscrew the fixing bolt of the top HDD bay ② and separate the top HDD bay ② from the body.

3) Using a screw driver, unscrew the fixing bolt of the bottom HDD bay ① and separate the bottom HDD bay ① from the body.

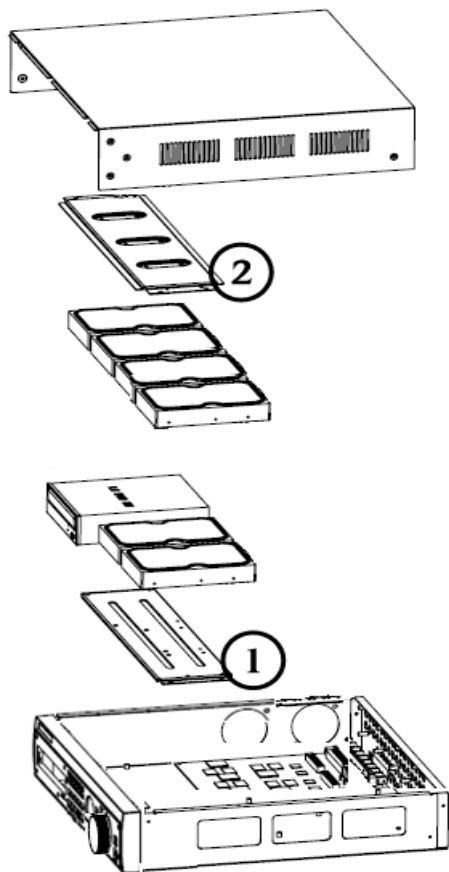

※ Step 3

- 4) Align screw holes and screw and fix HDD onto the bottom HDD bay①.
- 5) Align screw holes and screw and fix HDD onto the top HDD bay②
- 6) By reversing Step 2, combine both top② and bottom① HDD bay with the body.



1) Deluxe model can hold HDD up to 6ea
2) HDD power and data terminal should face the inner direction.



※ Step 4

- 7) Connect the power cable and data cable to HDD.

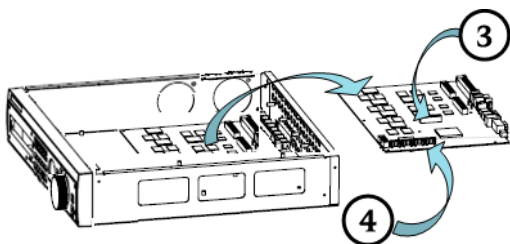

※ Step 5

- 8) Power terminals(③). Connect the power cable into the power terminal(③).



※ Deluxe model model has a different type of SATA power cable.

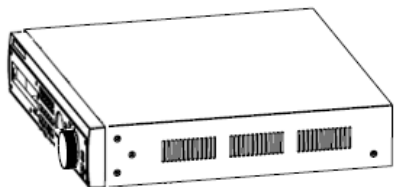

- 9) Connect the HDD data cable into the mainboard data cable connector(④).



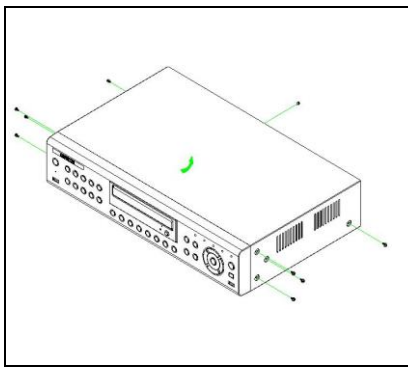

※ Step 6

- 10) Reassemble the top case by reversing 1) to finalizing HDD installation.

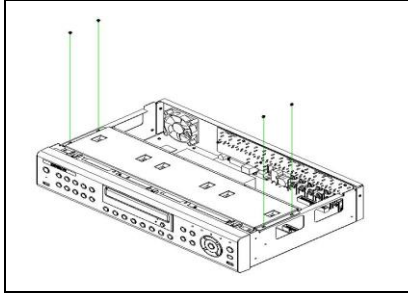
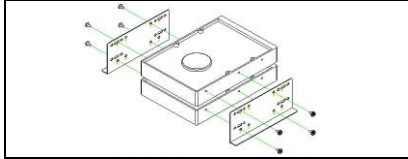
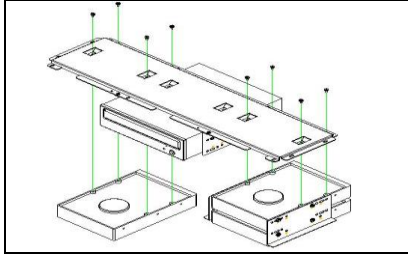
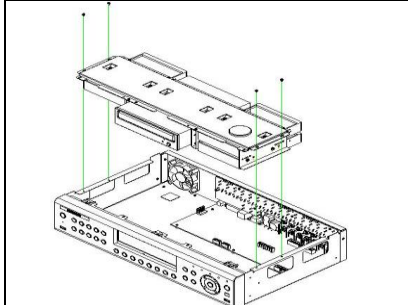
4-2 Blue Series Storage Installation

	<p>1) Open the top case by using screw driver.</p> <div data-bbox="592 416 1410 589" style="border: 1px solid black; padding: 5px;"><p>Caution</p><p>1) Normal termination of the system and fully unplugged power code are required before conducting HDD installation. 2) Touch a grounded metal substance or ground yourself before installing HDD in order to reduce static electricity. Static electricity may cause a malfunction of the product. 3) After installing HDD, Do not connect to power supply with the top case opened. The top case must be covered before usage.</p></div>
	<p>2) Unscrew and separate the HDD bay from body.</p>
	<p>3) Screw the HDDs to the HDD bay.</p>
	<p>4) As per the photo, Screw the HDD bay, HDD and DVD to the top bay.</p>
	<p>5) Connect the power cable and data cable on HDDs and then reassemble the top case by reversing 1) to finalizing HDD installation.</p>

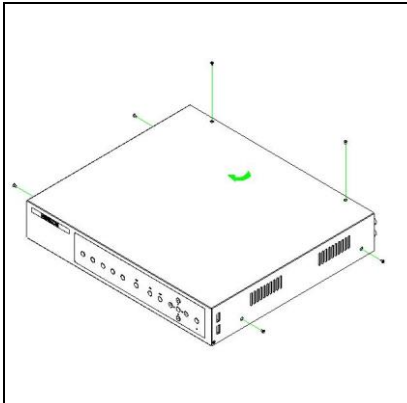
4-3 Lite Series Storage Installation

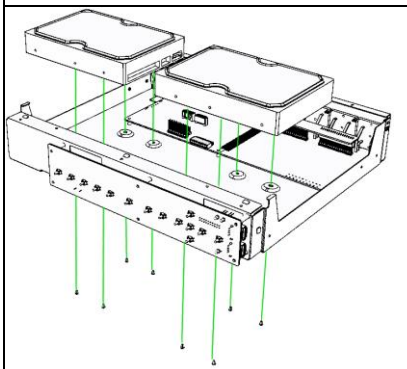
	<p>1) Open the top case by using screw driver.</p> <div style="border: 1px solid black; padding: 5px;">  <p>Caution</p> <p>1) Normal termination of the system and fully unplugged power code are required before conducting HDD installation. 2) Touch a grounded metal substance or ground yourself before installing HDD in order to reduce static electricity. Static electricity may cause a malfunction of the product. 3) After installing HDD, Do not connect to power supply with the top case opened. The top case must be covered before usage.</p> </div>
	<p>2) Unscrew and separate the HDD bay from body. 3) Screw the additional HDD bay to current HDD bay 4) Connect HDD to HDD connector on the main board directly without cable. Reassemble the top case by reversing 1) to finalizing HDD installation.</p>

4-4 Power ON.

- ① Check the Power, DELUXE-16 Model (90 ~ 250V, 50/60Hz) and connect the power.
- ② Once Power cable is connected (found in Rear Side), booting will be enabled. .
- ③ After booting is finished, the live screen and channel indication / clock are shown.
- ④ Menu window pops up by clicking the right button of the mouse or pressing [MENU] button in the front panel as shown below.



[Figure 4-8. Menu Window]



ID and Password are required for initial installation. Default ID and Password are shown below.
 [admin : 00000] [User1 : 1111111] [User2 : 2222222]
 [User3 : 3333333] [User4 : 4444444].... [User10 : aaaaaaa] [User11 : bbbbbbb]....
 ※ Password is available to change at {Menu} → {Setup} → {System} → {Modify}.

4-5 Storage Setup

- ① Select {Menu} → {Setup} → {Storage} and configure HDD.



For more detail about HDD and external devices, check [6-5 Storage].

4-6 Recording Setup

- ① Select {Menu} → {Setup} → {Recording} → {Recording}

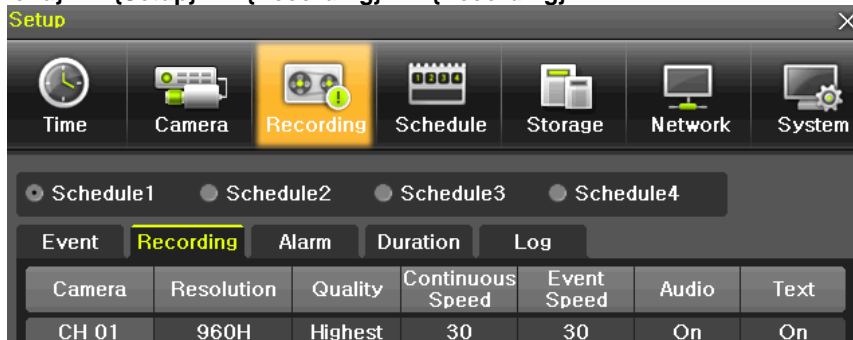

- ② Setup [Recording Resolution]/[Recording Quality]/[Continuous Speed]/ [Event Speed]/[Audio]/[Text].



The initial recording setup is [Recording Resolution: 960H] [Recording Quality: High] [Continuous Speed: Off]. An image of the connected cameras is recorded with above setting. For more detail, check [6-3 Recording Setup].

4-7 Date/Time Setup

- ① Select {Menu} → {Setup} → {Time}.
- ② Configure [Time Server]/[Date and Time]/[Standard Time Zone].

4-8 Camera / TV Setup

- ① Select {Menu} → {Setup} → {Camera} → {Adjust}.

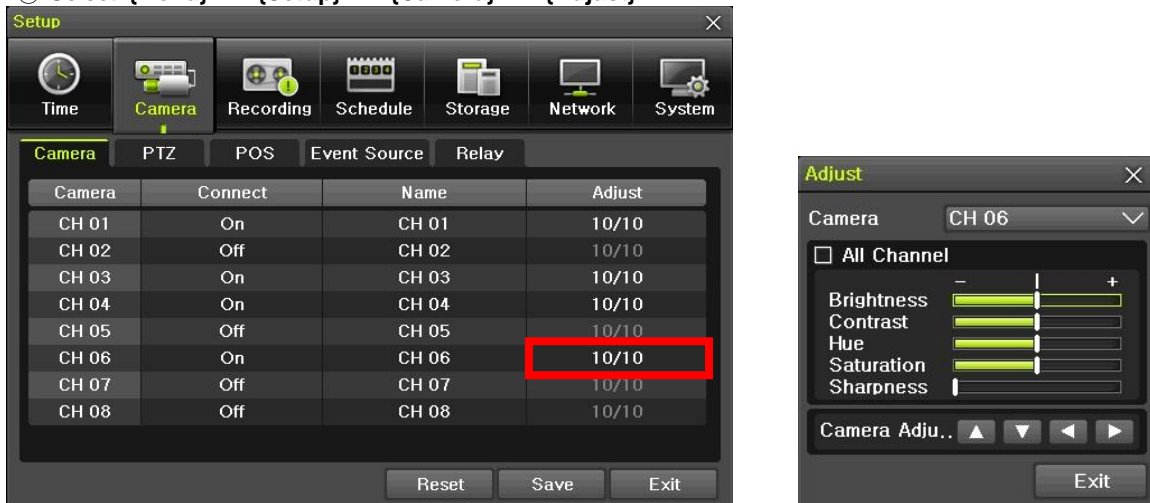

- ② Set up for [Brightness/Contrast/Color/Hue/Camera Adjustment/TV OUT Adjustment] are available.

4-9 Display Setting and Other Setup

- ① Select and set up {Menu} → {Miscellaneous} → {Display Setting}.

4-1 0 External Device Setup

- ① Configure external devices. For more information, check [2-3 Connection of other devices], [Chapter 5. System Operation], [6-2 Definition], [6-6 Network], [6-7 System].

4-1 1 Search

- ① For more information, check [5-6 Search], [5-7 Calendar Search], [5-8 Playback], [5-10 Recording].

4-1 2 Backup

- ① Backup is available in Monitoring, Search, Log and Playback Mode.
② For more information, check [5-11 Backup].

4-1 3 DVR Info.

- ① Move to {Menu} → {Miscellaneous} → {DVR Info}.



Caution

Detail information for product functions are described below in this manual.

Chapter 5 . System Operation

5-1 Real Time Monitoring Mode and Icon

After booting is finished, Audio/Recording Status/Channel Title/Connection Status/Time/HDD Status are displayed as shown below.



[Figure 5-9. Recording Status Window]

※ Recording Event / Recording Mode Icon ※		
Recording Event		Motion Detection Recording
		Sensor Recording
		Audio Recording
		Text Recording
Recording Mode		Video Recording
		Audio Recording
		Text Recording

※ Recording Event Icons are still displayed despite of the recording stop. Recording Mode Icon distinguish recording status.

※ Live Screen Icon ※	
	Video is not connected
	Audio is activated.
	Audio is mute
No Signal	Camera has been disconnected.

※ Control Bar ※	
①	Full Screen
②	4 Channel Screen
③	8 Channel Screen
④	16 Channel Screen
⑤	ZOOM function
⑥	Auto Sequence Mode
⑦	Date / Time
⑧	HDD Status
⑨	Playback

5-2 System Login

5-2-1 User Account and Authorization

System users are divided into local administrators and general users and the local administrator can use all functions.

Local Admin	The local administrator can use all functions: System Power On/Off, Setup, Monitoring, and Playback .(remote access is not available, however)
User	Up to 15 users are allowed. Each user can access the functions depending on the given authorities. For Authorization Setup, Move to {Menu} → {Setup} → {System} → {4. User Registration} .

※ Functions available for Authorization Setup	
Network Live	View the real-time image by network access.
Playback	View the recorded image.
Copy (Download)	Copy and download the image from the network.
PTZ Control	PTZ camera control
Setup	Recording, Recording Schedule, System, Storage, Time, PTZ, Network Setup, Screen Setup
Network Upgrade	Remote network upgrade
View Covert Channels	Enable viewing covert channels.

5-2-2 Login

For security purpose, user must log in first to use **{Monitoring Menu}**.

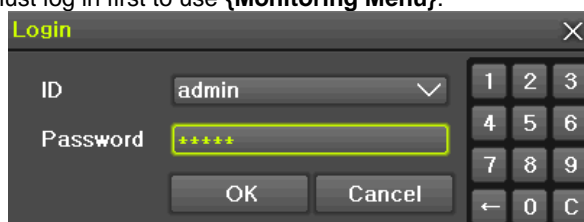

[Figure 5-10. Login Window]

- ① On the real-time monitoring window, select **{Menu}** → **{Login}**.
- ② Enter the password or select cancel.

5-2-3 Logout

After logging out, the user cannot use {Menu}.

- ① On the real-time monitoring screen, select {Menu} → {Logout}.

5-3 Monitoring

HD SDI Universal Series features powerful monitoring functions as shown below.

- 1 / 4 / 9 / 16 Division Mode and Auto Sequence Mode
- Channel Grouping
- 1/4/9/16 Multi spot
- TV mode
- Menu Controlling in Monitoring Mode
- Zoom
- Live Event Indication
- Text Detection by using POS → Only 1ch
- Screen Control by using PTZ.

5-3-1 Screen Division and Auto Sequence

After the system is booted, images will be displayed on a screen divided into [16/9] division depending on the model. Except for the basic setting, the system follows user's setting on the screen division from next booting. H-model series provides the 7 screen division mode including 1 / 4 / 9 / 16 / Auto Sequence and 1/4/9/16 are Basic Mode.

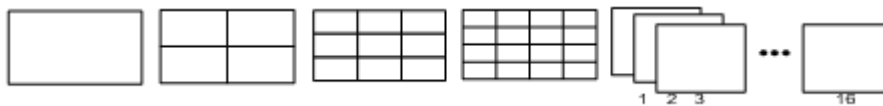

[Figure 5-11. HD-SDI Universal model 16CH Channel Mode]



[Figure 5-12. HD-SDI Universal model 8CH Channel Mode]

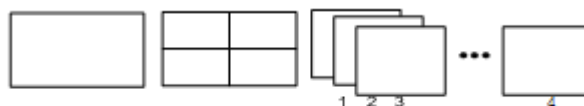

[Figure 5-93. HD-SDI Universal model 4CH Channel Mode]

※ In Basic Mode ;1/4/9/16, pressing the same mode button leads to screens as shown below.																			
1 Channel Division Mode (16 Group)																			
4 Channel Division Mode (4 Group)	<table border="1" style="display: inline-table; border-collapse: collapse; text-align: center;"> <tr><td>1</td><td>2</td><td>5</td><td>6</td><td>9</td><td>10</td><td>13</td><td>14</td></tr> <tr><td>3</td><td>4</td><td>7</td><td>8</td><td>11</td><td>12</td><td>15</td><td>16</td></tr> </table>	1	2	5	6	9	10	13	14	3	4	7	8	11	12	15	16		
1	2	5	6	9	10	13	14												
3	4	7	8	11	12	15	16												
9 Channel Division Mode (2 Group)	<table border="1" style="display: inline-table; border-collapse: collapse; text-align: center;"> <tr><td>1</td><td>2</td><td>3</td><td>8</td><td>9</td><td>10</td></tr> <tr><td>4</td><td>5</td><td>6</td><td>11</td><td>12</td><td>13</td></tr> <tr><td>7</td><td>8</td><td>9</td><td>14</td><td>15</td><td>16</td></tr> </table>	1	2	3	8	9	10	4	5	6	11	12	13	7	8	9	14	15	16
1	2	3	8	9	10														
4	5	6	11	12	13														
7	8	9	14	15	16														
16 Channel Division Mode (1 Group)	<table border="1" style="display: inline-table; border-collapse: collapse; text-align: center;"> <tr><td>1</td><td>2</td><td>3</td><td>4</td></tr> <tr><td>5</td><td>6</td><td>7</td><td>8</td></tr> <tr><td>9</td><td>10</td><td>11</td><td>12</td></tr> <tr><td>13</td><td>14</td><td>15</td><td>16</td></tr> </table>	1	2	3	4	5	6	7	8	9	10	11	12	13	14	15	16		
1	2	3	4																
5	6	7	8																
9	10	11	12																
13	14	15	16																

※ The user can view an image on full screen by double-clicking a desired channel in the 4/9/16 Sub-Screen mode. Double-click any part of the screen to return to the previous mode.

※ **Auto Sequence**

Auto Sequence is to rotate images at an interval of the certain time in 1/4/9 Basic Division. **Auto Sequence is not available in the Basic 16 Division mode.**

- ① Move to {Menu} → {Miscellaneous} → {Display Setup }.



- ② Pressing Front {SELECT} Button / Remote Controller {SELECT} Button / Mouse Arrow Button initiate the Auto Sequence mode.



- ③ Auto Sequence in Basic 1 / 4 / 9 Division Mode

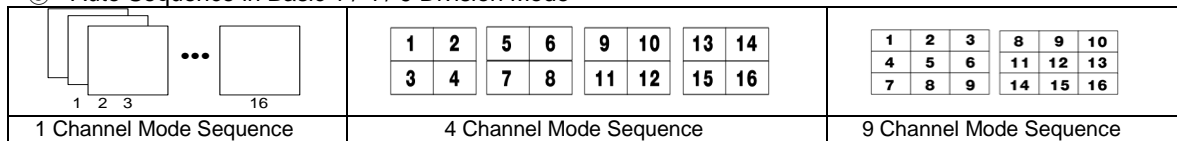

5-3-2 Spot

Spot is to output a channel that is set with a certain function and Spot has an independent monitor and output. The priority for Spot is Manual Spot > Event Spot > Sequence Spot.

- ① Manual Spot

The user can designate a spot channel manually. DELUXE-16 Model 16CH supports 4ea Spot channels.

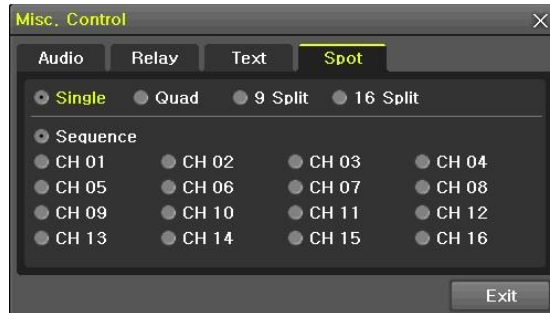

[Figure 5-14. Spot]

- ② Move to {Menu} → {Miscellaneous} → {Misc. Control} → {Spot} and configure on the Single mode, Quad mode, Sequence and Channel.

③ **Event Spot**

Event Spot is to show a channel quickly that is set with the event function in case events (Sensor, Motion and Audio) occur. The event check interval is one second. If events are detected in many channels, it shows a channel with the last event. Move to {Menu} → {Setup} → {Recording} → {Alarm} → {Spot}.

④ **Sequence Spot**

The user can select more than one channel in Manual Spot and have a sequential image through Spot. Move to {Menu} → {Miscellaneous} → {Control} → {Spot} → {Sequence}.

5-3-3 Menu in Monitoring Mode

The user can control all functions available in Monitoring Mode in {Menu}.

- ① Press the Menu or right-click mouse button. The {Menu} will then appear.
- ② Select the desired item by using the arrow keys or mouse.
- ③ Press the ESC button or right-click mouse button to end the menu.

5-3-4 Zoom

Zoom is to zoom in or out the 1 channel division image in the real time monitoring mode.

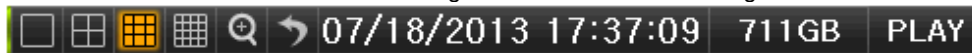

- ④ Move to {Menu} → {Zoom} or press the zoom icon from the control bar in the real time monitoring mode.
- ⑤ After selecting a channel, it becomes the 1 channel mode and the zoom control screen shows at bottom-right.



[Figure 5-105. Zoom Control Screen]

- ⑥ In case of the mouse, move the pointer to an area to be zoomed in the zoom control screen and double-click on it.
- ⑦ Then, it zooms in 3 levels; Normal, x4, x16. Those 3 levels can be controlled by the wheel of the mouse. The user also can left-click and drag the yellow box to move the focused image in higher than the x4 mode.
- ⑧ In case of the remote controller and front panel, it is available to move to 3 levels by using



{SELECT} button in the remote controller and



{SELECT} button of the front button.

The yellow box can be moved by the arrow keys.

5-3-5 Screen Control by using PTZ

This enables the user the real-time monitoring by using PTZ camera.

The PTZ camera must be connected to the system. For external connection, refer to [2-3 Connection of Other Devices] → [3] Terminal block]. Select {Menu} → {Setup} → {Camera} → {PTZ}.

- ① Configure Protocol / ID / Baud Rate / Duration / Tour.

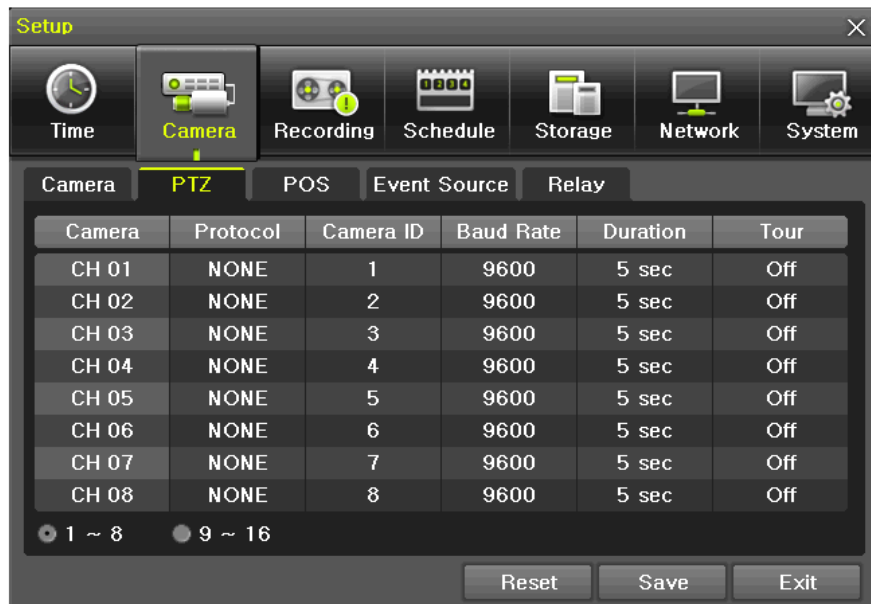

[Figure 5-16. PTZ Setup]

- ※ Baud rate can be selected at 2400/4800/9600/19200/38400.
- ※ Duration can be selected at 5/10/15/20/5-60(User setting) seconds.
- ※ Tour consists of Tour 1/ Tour 2 and each tour can be set with 8 Preset.



※ DELUXE-16 Model series supports 28 protocols for PTZ control. For supported protocols, refer to APPENDIX.

- ② To control PTZ camera, select {PTZ Control} in Menu or press {PTZ} in the remote controller.



[Figure 5-17. PTZ Control]

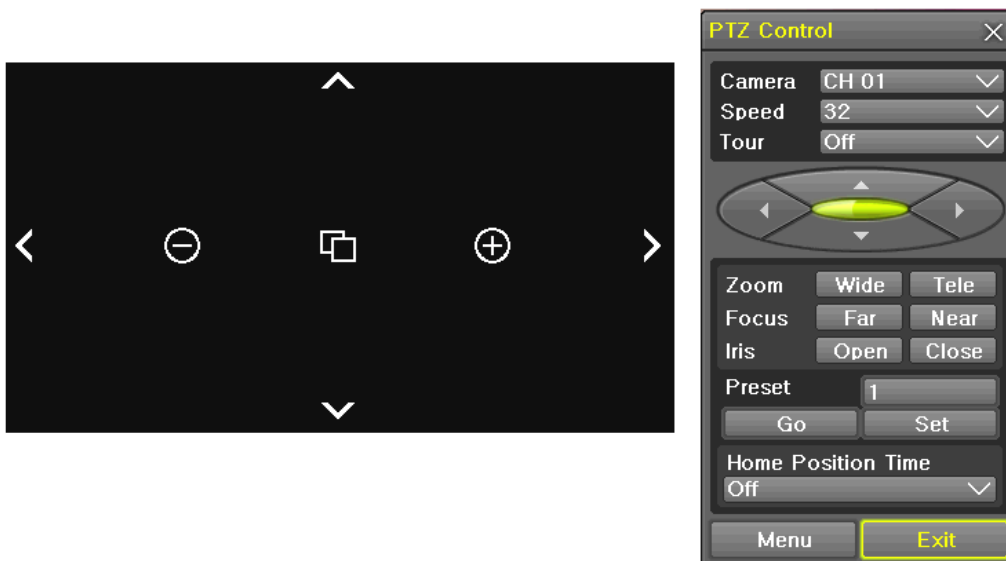

[Figure 5-18. PTZ Control Mini/Full]



In the PTZ mode, there are two function; Full and Mini. Tour has [Tour1] and [Tour2]. Home Position Time is 1/5/10/User setting(1-60)minutes.



Preset? Using horizontal/vertical/Zoom/Focus/Iris movement of PTZ Camera, zoom or focus or Iris a certain spot of the image by designating the coordinates and move to the designated coordinates quickly.



Home Position Time? If there are no controlling signals to PTZ camera after a certain time, it goes automatically to the Preset No.1 position as Preset No. 1 is designated as Home Position

5-4 System Information and Screen Setup Change

5-4-1 System Information

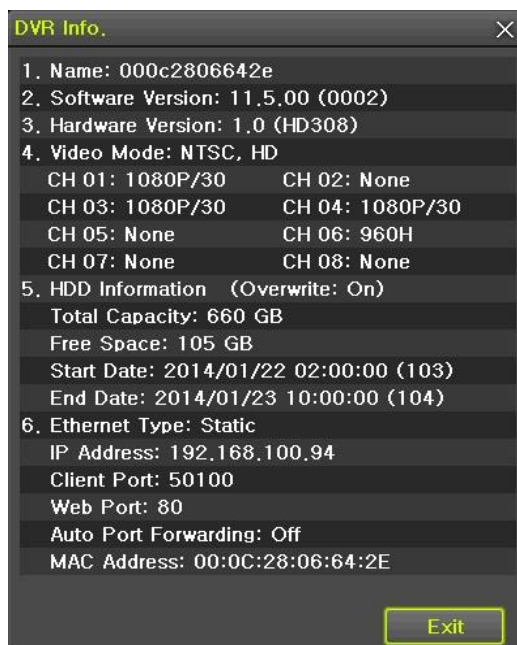

[Figure 5-119. Product Information Window]

5-4-2 Screen Brightness/Contrast/Color/Saturation/Sharpen/Camera Adjustment

Select {Adjust}, then it becomes the 1 channel mode and a window pops up as shown below.

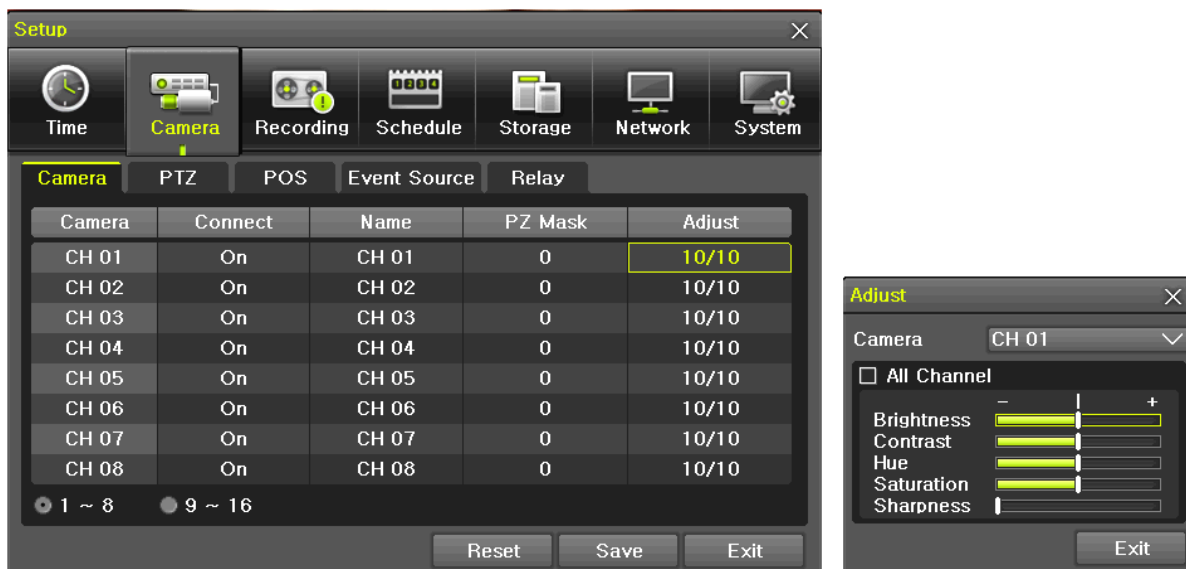

[Figure 5-20. Screen Setup Window]



Moving the camera, down, right, or left excessively may cause black or gray areas to appear on the screen. The level at which such condition does not occur is the proper control range for the camera.

5-4-3 Display Setting

Camera Title On/Off, Control Bar On/Off, Button Sound On/Off, Border Line Draw/Width/Color, Sequence Duration 1-10seconds. After selecting Display Setting, it becomes the 1 channel mode and a menu pops up as shown below.



[Figure 5-21. Display Setting Window]

5-4-4 Screen Saver

Monitor connected with DVR can be shut down to protect monitor. {Menu} → {Miscellane..} → {Display Setting} → {Screen Saver}

Name	Function
Duration	Screen Save duration setting
Starting	Screen Save starting setting, 0 to 24
Waiting Time	Screen Save activating term when there is no input



[Figure 5-22. Display Setting Window]

5-5 Control

In the real-time monitoring, move to {Menu} → {Miscellaneous} → {Misc. Control}.

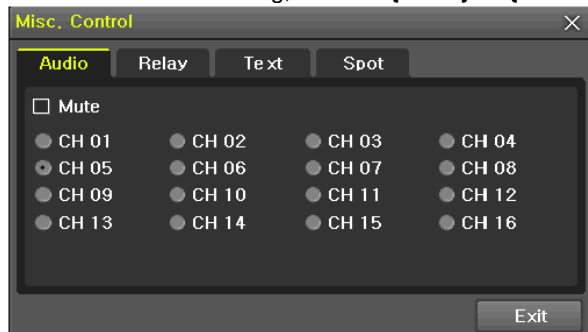

[Figure 5-23. Audio]

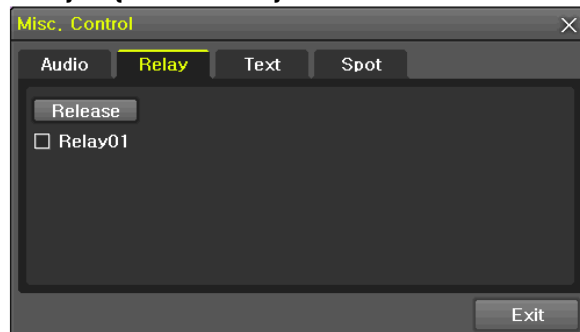

[Figure 5-24 . Relay]

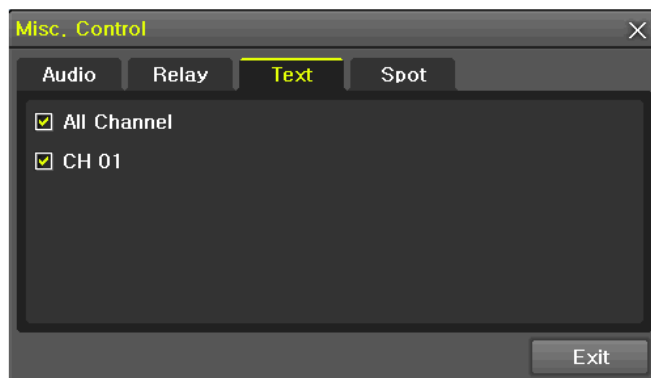

[Figure 5-25. Text]

① Move to the Audio tab and select the channel to be activated or Mute.



HD-SDI Universal 16CH model support 16 channel audios, HD-SDI Universal 8CH model support 8 channel audios and HD-SDI Universal 4CH model support 4 channel audios.

② Move to the Relay tab and select.



All HD-SDI Universal models support 1 channel output.

③ Move to the TEXT tab and select.



Regarding Ethernet POS, 16CH model support 8ch POS, 8CH model support 4ch POS, 4CH model support 1ch POS. Also all DVRs support 1ch mode for RS232 POS.

5-6 Search

5-6-1 Search Mode

Move to **{Menu}** → **{Search}** in the real-time monitoring mode.



[Figure 5-26. Playback Menu]

5-6-2 Playback Menu

(1) Calendar Search

Calendar Search allows the user search and playback by [Year/Month/Day/Hour/Minute],[Multi-Channel/Multi-Time/Multi-Day]and [Motion/Sensor/Audio/Pattern].

(2) Go To The Last

The user can search and playback the last recorded data by Multi-Channel Mode.

(3) Go To The First

The user can search and playback the first recorded data by Multi-Channel Mode.

(4) Go to The Last Played Time

The user can playback from the last played time by Multi-Channel Mode.

(5) POS Search

Text Data can be searched and used for playback [Year/Month/Day/Hour/Minute],[Text 1~3]



※ Go To The First and Go To The Last are only available in **{Multi-Channel}**.

5-7 Calendar Search

5-7-1 Search Mode

On the real-time monitoring screen, select **{Menu}** → **{Search}** → **{Calendar Search}** and then a searching window pops up as shown below.

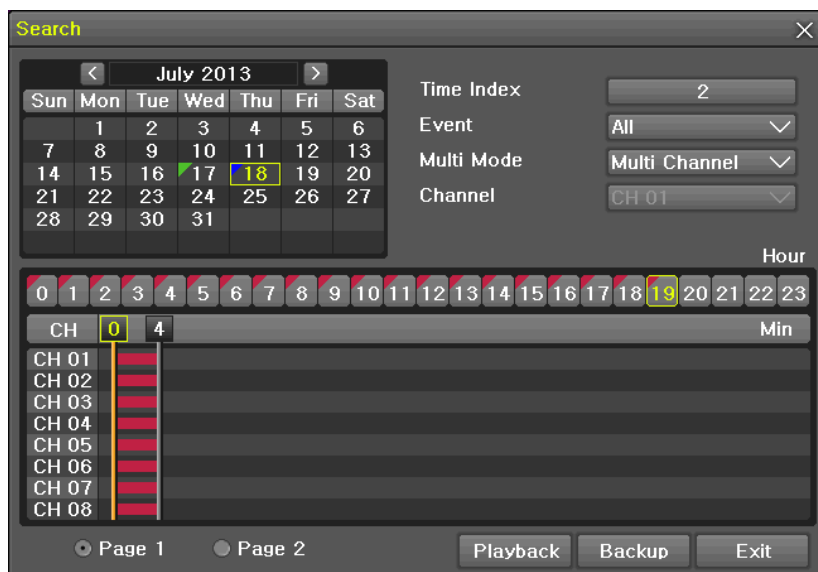

[Figure 5-27. Search Window]

5-7-2 Year/Month/Day Selection

Select the desired [Year/Month/Day]. The color of the icon at the top-left of square in the calendar indicates the recording status.

5-7-3 Time Index

- ① Every time when the user changes the time at {Menu} → {Setup} → {Time} → {Date and Time} tab, a new folder(Index) is created and files saved in the folder before the time change can be found at {Menu} → {Calendar Search} → {Time Index}.
- ② Selecting a file at {Menu} → {Calendar Search} → {Time Index} leads to a selection window pop up and the user can select a file in different folders (before time change).

	
Start Time	The Recorded Start Time
End Time	The Recorded End Time

5-7-4 Event

Event is to search the data by the events. Select [All/Motion/Sensor/Audio/Pattern/Text].

5-7-5 Multi-Channel Search

The Multi-Channel Search is to play recorded images of the different channel over a certain designated time.

- ① Select the desired Year/Month in the calendar window.
- ② After selecting the desired search date, each channel is then displayed in the hour bar graph.

 The bar graph color in the real-time monitoring mode is same with recording event functionally.

- ③ Move the time line to a specific time point by using the arrow keys or the numeric buttons and press the Search button.
- ④ Selecting the time leads to the recorded video display of each channel in the minute bar graph.
- ⑤ Move the time line to a certain time point by using the arrow keys and the numeric buttons and press the Select button. Playback will then start from the specified time point.

5-7-6 Multi-Time Search

The user can playback the video contents of the certain channel recorded in the different time zone simultaneously.

Entering into the search mode during the Multi-Time playback leads to the Multi-Time Search.

- ① The way of the date search is same as the Multi-Channel Search.
- ② The hourly recording status of the selected date is viewed after selecting a desired date.
- ③ Select the start time and channel by using the arrow keys.
- ④ The hourly displayed video of the selected channel will then be displayed in the minute bar graph.
- ⑤ Move the time line by using the arrow keys and the numeric buttons and specify the time. Afterward, press the Start button and play back the contents.



※ A different time zone means continuous 16 hours.

5-7-7 Multi-Day Search

The user can playback the video contents of the certain channel recorded in different dates simultaneously. Entering into the search mode during the Multi-Day playback leads to the Multi-Time Search.

- ① The way of the date search is same as the Multi-Channel Search.
- ② The date list and the hourly recording status starting from the selected date are viewed by selecting the desired date.
- ③ Select the start time and channel by using the arrow keys.
- ④ The recorded video of the selected channel will then be displayed as the minute bar graph.
- ⑤ Move the time line by using the arrow keys and the numeric buttons and specify the time. Afterward, press the Start button and play back the contents.

5-7-8 List All

To check Time index in order of time line.

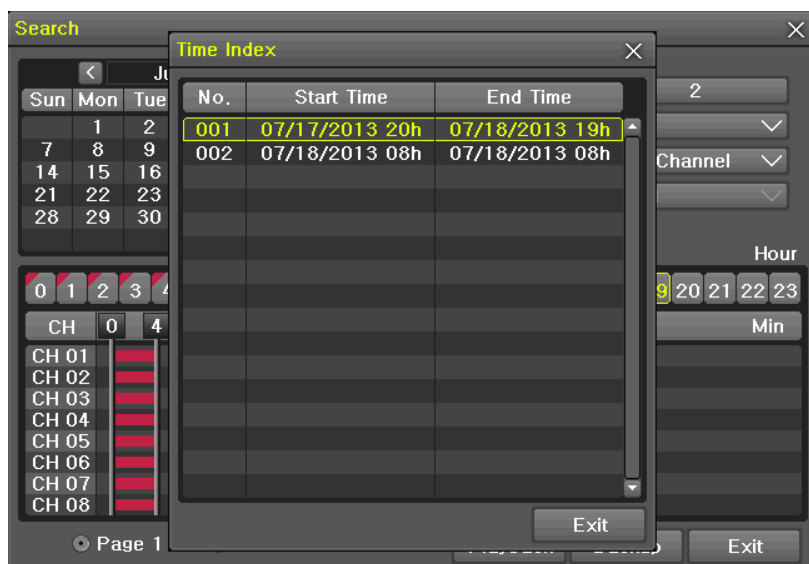

[Figure 5-28. Time Index]

5-8 POS Search

5-8-1 POS Search Mode

On the real-time monitoring screen, select {Menu} → {Search} → {POS Search} and then a searching window pops up as shown below.

5-8-2 Year/Month/Day/Text/Time Selection

Please select date/time, Time index, Text 1~3, and select the start time within the channel..

5 - 8 - 3 Search / Playback

After selecting the 'Start' Button, '1 searched item' needs to be selected in order for 'playback' to start.

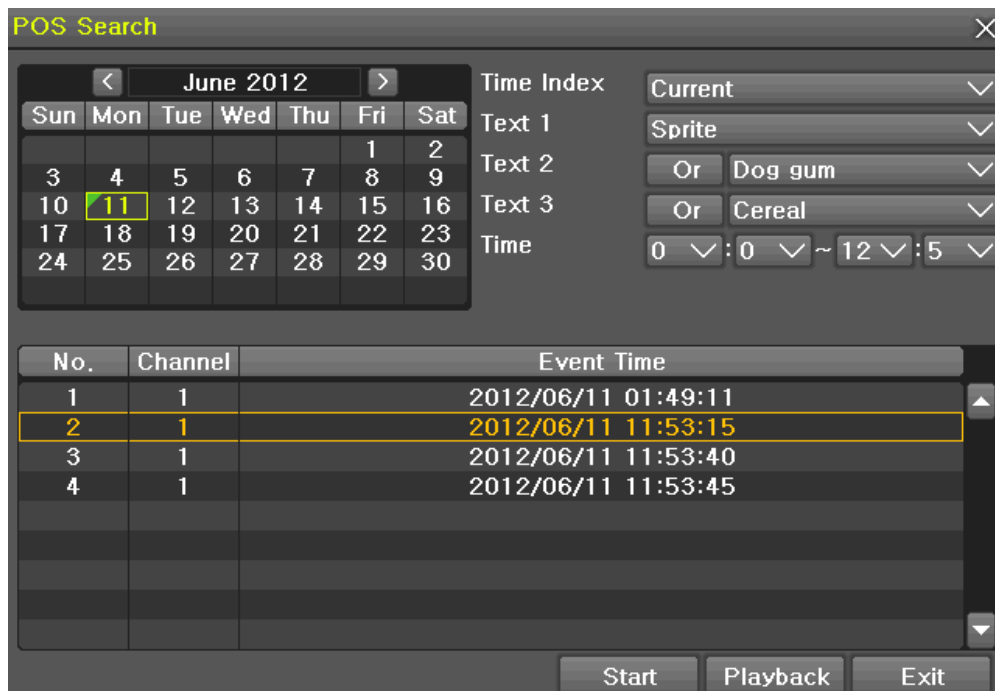

[Figure 5-29. POS Search]

5-9 Playback



[Figure 5-30. Playback Screen]

※ There are five routes to play the recorded image.



- Playback in the Calendar Search
Select **{Playback}** in **{Menu}** → **{Search}** → **{Calendar Search}** → **{Search}**.
- Playback in the Go To The Last
Select **{Menu}** → **{Search}** → **{Go to The Last}**.
- Playback in the Go To The First
Select **{Menu}** → **{Search}** → **{Go To The First}**.
- Playback in the Last Played Time
Select **{Menu}** → **{Search}** → **{The Last Played Time}**.

➤ Playback in the Log View
 After selecting {Menu} → {Miscellaneous} → {Log Viewer}, select or double-click the time line listed to play.

※ HD-SDI Universal series provide a variety of the playback.









- Smart Search
- POS Search
- Calendar Search
- Multi-Time
- Multi-Day
- Multi-Channel
- Panorama Play
- Event Play
- Zoom Play

5-9-1 Playback and Playback Speed Control

- ① In the Playback mode, the user can play back video contents by using buttons as shown below.
- ② After the data is played to the end, the data of the next time zone will be automatically searched and played (this function is possible only in the Multi-channel Playback mode; both backward playback and forward playback are possible).
- ③ Pressing   buttons, the user can adjust the playback speed by (x 1) / (x 2) / (x 4) / (x 8) / (x 16) / (x 32) / (x 300).



[Figure 5-31. Playback Status and Control Window]

Description of the Search Buttons		
Button	Name	Features
	Channel Mode Change	Switch the channel mode.
	Zoom Mode	Switch to the Zoom mode.
	Forward Play / Fast Forward	Press one time - Playback forward (x 1) Press two times - Fast forward (x 2) Press three times - Fast forward (x 4) Press four times - Fast forward (x 8) Press five times - Fast forward (x 16) Press six times - Fast forward (x 32) Press seven times - Fast forward (x 300) Pressing one more time in x300 leads to x1 back.
	Forward Frame by Frame	Playback frame-by-frame Pause
	Pause	Pause
	Reverse Frame by Frame	Reverse playback frame by frame Pause
	Reverse Play / Fast Reverse	Press one time - Playback reverse (x 1) Press two times - Fast reverse (x 2) Press three times - Fast reverse (x 4) Press four times - Fast reverse (x 8) Press five times - Fast reverse (x 16) Press six times - Fast reverse (x 32) Press seven times - Fast reverse (x 300) Pressing one more time in x300 leads to x1 back.
	ESC	Exit out of Playback Mode.

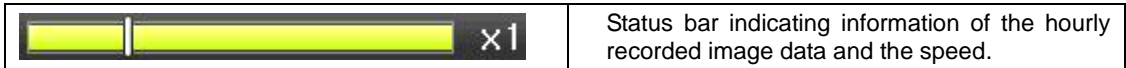

Status bar indicating information of the hourly recorded image data and the speed.

Selecting the right-mouse button or menu button in the Playback Mode pops up the **{Playback Menu}** as shown below.



[Figure 5-32. Playback Menu]

5-9-2 Smart Search

This function is used to search an image with the object movement at a specific zone quickly. Searching by each channel and a detail control are available.

Type	Content
Sensitivity	5 levels; Lowest / Low / Middle / High / Highest
Minimum	Mosaic pixel control available between 1- 10
Quick Search	In the NTSC mode, search 30 frames once. In the PAL mode, search 25 frames once.
Detail Search	Search all frames.

- ① Move to the Smart Search and select the desired channel.
- ② After shifting to the 1 channel mode, select areas to be smart searched.



[Figure 5-33. Smart Search Area Designation]

- ③ The 14 * 15 pixel mosaic mode appears. In the beginning, all pixels are selected. Designate an area by left-click and drag the pixel mosaic pointer(deep yellow). Designate another area by repeating the same way.



It detects motions in non-designated blocks.

- ④ Right-click brings up the menu as shown below. Configure each category and press the Playback button to start searching.

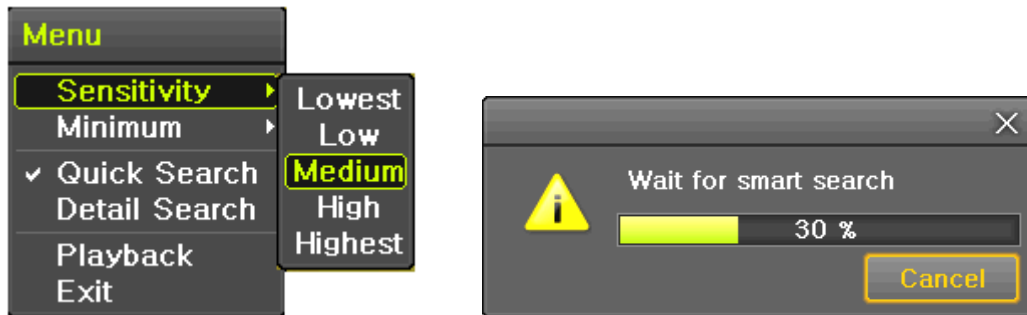

[Figure 5-34. Smart Search Motion Detection Window]

- ⑤ It may take time during the searching. Start the playback after searching.

5-9-3 POS Search

The Text Data recorded needs to be searched in order to Playback

5-9-4 Calendar Search

Move to {Menu} → {Search} → {Calendar Search} and then a searching window pops up.

5-9-5 MULTITIME

The user can playback the video recorded image of the certain channel recorded in different time zones simultaneously. The arrangement of the searching result is the past to recent format.

5-9-6 MULTIDAY

The user can playback the video recorded image of the certain channel recorded in different dates simultaneously. The arrangement of the searching result is the past to recent format.

5-9-7 MULTICHANNEL

Multi-Channel Search is to play recorded images of the different channel over a certain designated time.

5-9-8 Panorama Play

Panorama Play is to play recorded images of the certain channel frame by frame. Panorama Play can be viewed at 16 frame / 8 frame / 4 frame / 1 frame.



[Figure 5-35. Panorama Playback]

5-9-9 Event

Event is to search and play events [All/Motion/Sensor/Audio].

5-9-1 0 Backup

The user can save the backup image data and capture the image into [CD/External Device].

Backup	Save the recorded data into [CD/External Device].
Snapshot	Capture and save the current displaying screen.

5-9-1 1 Screen Mode

Screen division is available in the Playback mode as same in the Monitoring Mode. [1 / 4 / 9 / 16 Mode] can be selected.

- ① Select the screen division mode by using the mouse or arrow keys in the front panel and remote controller.



[Figure 5-36. Display Mode]

5-1 0 Log Viewer

DVR records all Log information over the system operation including Power on/off, System Setup and Network Access. Move to {Menu} → {Miscellaneous} → {Log Viewer} to see the logs.

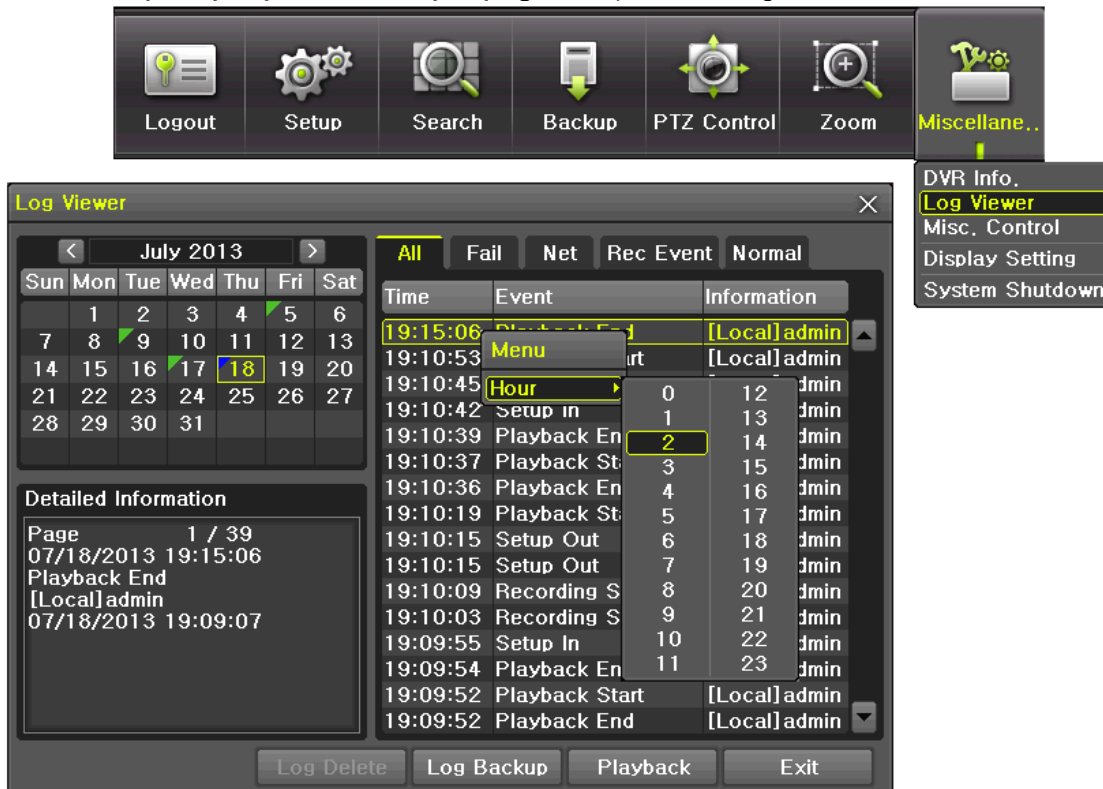

[Figure 5-37. Log View]

5-1 0-1 Log Type

General	Logs related to power ON/OFF, file copy/backup failure, setup start/end, playback, and other basic system operations
Recording Event	Logs related to the recording including motion detection and sensor detection, Audio detection
Network	Logs related to network operations including network login, network logout, and network live
Fail	Logs related to system operation failures including signal loss and network connection failure
All	Logs related to all system operations

5-1 0-2 System Log Viewer

- ① In the real-time monitoring mode, {Menu} → {Miscellaneous} → {Log Viewer}, then, Log List Window pops up.
- ② On the activated calendar window, select the desired date (year/month/day) by using the arrow keys and the Select button.
- ③ The user can check the time and the log type by using the arrow keys in the log list.
- ④ Use the Up/Down button to check the logs by time and type on each page.
- ⑤ The user can shift the focus to a certain time zone to play the certain time (playback will start from the time point when logs are saved)
- ⑥ Click the right-mouse button or select {Menu} button in the front panel and select {Hour} to move the desired log time zone.

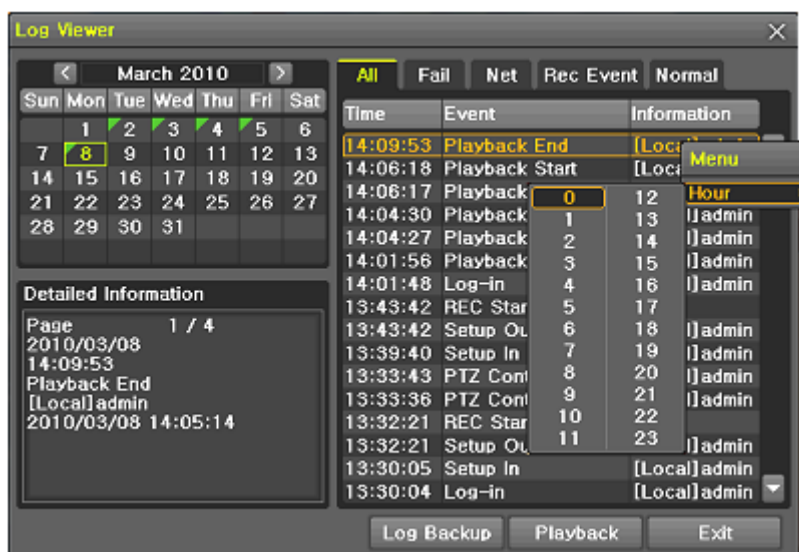

[Figure 5-38 . Move to the log list of the certain time zone in Log View]

	<p>Time Changed Log Data View</p> <p>The stored data folder is created each time the user changes the time. A blue triangular icon is displayed at a date in the calendar window that time changes are made. Otherwise, a red triangular icon is displayed at an unchanged date. To view the log details, select the desired date with a red icon. Selecting a date with the blue icon causes the changed date list window to appear.</p>
---	--

5-1 1 Recording

5-1 1-1 Recording Types

It supports various recording types as shown below.







Recording Type	Description
Continuous	The Continuous recording will be initiated based on the general frame rate.
Motion	When motion is detected, the recording will be initiated based on the event frame value.
Sensor	When input signal from an external sensor is generated, the recording will be initiated based on the event frame value.
Audio	When audio is detected, the recording will be initiated based on the event frame value.
Text	When a text is received from POS device, the text will be recorded.

5-1 1-2 Recording Setup

Go to {Menu} → {Setup} → {Recording} for the Recording Setup. For more information, move to {Menu} → {Setup} → {Recording} → {Recording}.

5-1 1-3 Recording Status View

(1) Recording Status by Color

※ Recording Event / Recording Mode Icon ※		
Recording Event		Motion Detection Recording
		Sensor Recording
		Audio Recording
		Text Recording
Recording Mode		Video Recording
		Audio Recording
		Text Recording

5-1 2 Backup

In order to backup the data, make sure to check that either internal or external storage devices (CD, DVD or HDD) supports USB 2.0 is connected. For supported external devices, refer to Appendix. The user can back up data in the real-time monitoring, search, log, or the playback mode.

5-1 2-1 Backup in The Real-Time Monitoring Mode

- ① In the real-time monitoring mode, select {Menu} → {Backup} → {Backup}. The backup menus will then appear.
- ② The automatic backup time is set to 5 minutes before the Copy (Backup) button is pressed, and the end time, to the time the Copy (Backup) button is pressed.
- ③ All channels containing data at the time of backup are backed up automatically. Depending on the divided screen mode, however, only those channels that can be viewed may be selected.
- ④ For the remaining backup procedures, see [5-33 Common Backup Procedure].

5-1 2-2 Backup in Search Mode

- ① Select {Menu} → {Search} → {Calendar Search}.
- ② Click the right-mouse button or select {MENU} button in the front panel.
- ③ The automatic backup start time is set to the year/month/date/hour/minute set in the search mode, and the end time, to the last minute/second of the data existing at the selected time.
- ④ All channels with existing data at the time of backup are backed up automatically.
- ⑤ For the remaining backup procedures, see [5-33 Common Backup Procedure].

5-1 2-3 Backup in Log Mode

- ① Select a date in {Menu} → {Miscellaneous} → {Log Viewer} and select a log related to the data to be backed up.
- ② Click the right-mouse button or select {MENU} button in the front panel.
- ③ The automatic backup time is set to 5 minutes before the selected log is generated, and the end time, to the time the selected log is generated.
- ④ All channels with existing data at the time of backup are backed up automatically. If a log has been generated for a specific channel, however, then only that channel is selected.
- ⑤ For the remaining backup procedures, see [5-33 Common Backup Procedure].

5-1 2-4 Backup in Playback Mode

- ① In the Playback mode, select {Menu} → {Backup}. Any playback in progress at this time will stop.
- ② The automatic backup time is set to 5 minutes before the Copy (Backup) button is pressed, and the end time, to the time the Copy (Backup) button is pressed.
- ③ All channels containing data at the time of backup are backed up automatically. Depending on the divided screen mode, however, only those channels that can be viewed may be selected.
- ④ For the remaining backup procedures, see [5-33 Common Backup Procedure].

5-1 2-5 Common Backup Procedure

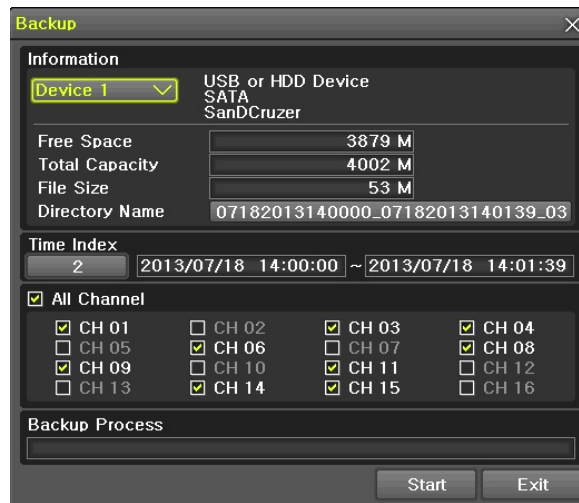

[Figure 5-39. Backup Window]

- ① [Figure 5-34] shows the initial backup window menus.
- ② A list of the devices that can be selected is outputted with simple information of the currently selected devices
- ③ Selecting a device by pressing the Select button causes the free space and total capacity for the selected device to be displayed.
- ④ Selecting a device causes the directory name based on the initial values for the time and channel to be displayed and the size of the file to be backed up to be calculated.
- ⑤ The directory is named as same with the backup time. The first 12 digits are determined by the year/month/day/hour/minute/second for From, and the 12 digits in the middle, by the year/month/day/hour/minute/second for To. The last 2 digits are determined by the number of folders in the selected device.
- ⑥ Selecting a device enables selecting the backup time as well. As a rule, the From time cannot be later than the To time, and the To time cannot be earlier than the From time.
- ⑦ To change the start and end time, press the Select button after choosing the start and end time. Change year/month/day/hour/minute/second by using arrow keys and press the ESC button.
- ⑧ Changing the backup time causes the name of the directory to be backed up to be changed as well.
- ⑨ If the file to be backed up exceeds the free space, its size is displayed in a yellow box in case the selected device is capable of rerecording and in a red box if not.

	If the backup storage device is not formatted, in case the box displaying the size of the file to be backed up is displayed in yellow, and if backup is executed by pressing the Copy (Backup) button, a prompt asking(Yes/No) whether to erase the device will appear. Selecting {YES} causes the storage medium for the selected device to be erased.
---	---

- ⑩ Press the Copy (Backup) button. A prompt asking(Yes/No) whether to proceed with the backup.



※ Select **[Yes]** to back up the data or **[No]** to stop the backup. Otherwise, press the **[Cancel]** button to return to the device selection mode on the backup window.

- ⑪ Select **{Yes}** to continue the backup.

5-1 3 Setup Backup

The Setup Backup is to back all setup values of the current menu up. This function enables the user to copy the setups and apply them into other devices.



[Figure 5-40. Backup and Sub-menu Setup Backup]

- ① For the Setup Backup, a device for backup must be connected.
- ② Move to {Menu} → {Backup} → {Setup Backup} and a window shown below appears. The setup is copied by the name shown below.

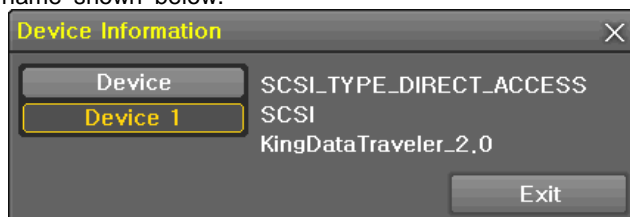

[Figure 5-41. Setup Upgrade]

Saved as the name below.
 HD116T_565645348945_80_01_20100303_113237.bin
 ① ② ③ ④ ⑤
 ① Model ② DVR name ③ Version ④ Date ⑤ Time

- ③ Move to {Menu} → {Setup} → {System} → {6. Upgrade} → {Setup} after insert the backup device.
- ④ With this way, the user can upgrade a new device with the current setup values in easy way.

5-1 4 Log Backup

This is to back logs up including General/ Recording Event / Network / Fail.

- ① Move to {Menu} → {Backup} → {Log backup} and start the backup process after selection of the events.

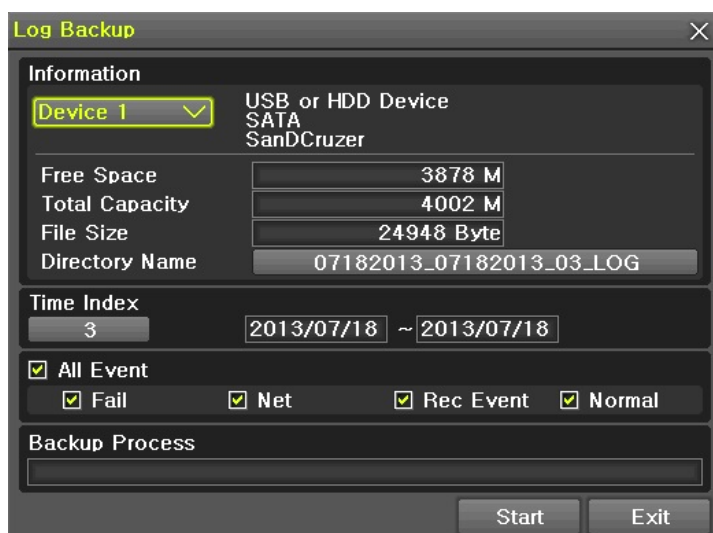

[Figure 5-42. Log Backup]

.Log files are created at a folder shown below.
 20100303_20100303_02_LOG
 565645348945_20100303.log
 .log file is the text file.

5-1 5 Capture

The Capture function lets the user create a JPG file in the real-time monitoring, playback, search, or log mode and back up the image data.

- ① To back up the currently displayed image, select **{Menu} → {Backup} → {Capture}** in real-time monitoring, Playback and Log mode.
- ② When only one USB2.0 backup device (excluding ODD devices) is searched, the JPG file is stored in the same device.
- ③ If there are no or more than two USB2.0 storage devices (excluding ODD devices), a window for selecting the device will be displayed.
- ④ If the selected device is an ODD device, a prompt asking whether to back up in the ODD device.

Chapter 6 . Setup

6-1 Time

※ Function Description

1. Time Synchronization

1) Synchronization with the NTP server

The time is synchronized once every hour with the NTP Server.

A. Automatic Setup

The nearest server from the user's zone will be selected for connection. If the connection fails, the next nearest server will be chosen.

B. User Setting

The user sets the URL or IP for the NTP server. If connection is not established, a message will be sent to the user, and the related log, saved.

If synchronization with the NTP server fails, synchronization with RTC will be established.

2. Daylight Saving Time (DST) Setup

Regardless of whether NTP server or DST server is referred to, DST is automatically processed according to the time.

3. Time Setup by User

The user can set the time directly.

For the NTP client setup, the user can read the time but not change it.

※ Move to {Menu} → {Setup} → {Time} to set up time functions.

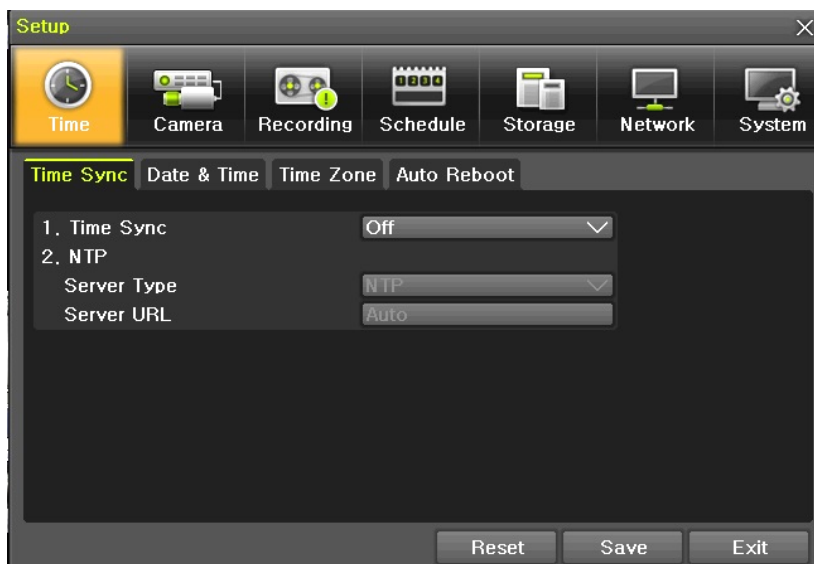

[Figure 6-43. Setup / Time Menu]

6-1-1 Time Sync

① Select Time Sever / Sever Type / Sever URL.

Off	The time server is not used.
NTP	NTP is used to set the time for the time DVR.



{NTP} setup is available when {Time Sync} is set as NTP.

The user can enter the IP only when the server type is DVR. For the NTP server, Automatic, IP, or URL should be selected.

6-1-2 Date and Time

(1) Date and Time



Only available when Time Server is off.

The system date and time format is Year/Month/Day Hour/Minute/Second.

- ① By using the arrow keys and the Select button, move the focus onto the desired field; Year/Month/Day Hour/Minute/Second and press the Select button.
- ② Select a field you want to change by using the arrow buttons and press the Select button.

(2) Time Display Format

Select Time Display Format among [Day/Month/Year] / [Month/Day/Year] / [Year/Month/Day].

6-1-3 Standard Time Zone

(1) Standard Time Zone

- ① Select {Standard Time Zone}.
- ② On the selection window, select the standard time zone you want to set.

(2) DST

- ① By using the arrow keys and the Select button, select {Summer Time}.
- ② On the selection window, select On/Off by using the arrow keys and the Select button.

(3) Start Time

- ① By using the arrow keys and the Select button, select {Start Time}.
- ② On the selection window, set up Start Time by using the arrow keys and the Select button.

(4) End Time

- ① By using the arrow keys and the Select button, select {End Time}.
- ② On the selection window, set up End Time by using the arrow keys and the Select button.



- ※ For a weekly setting in the {Start Time} and {End Time} fields, set Day to 0.
- ※ After the Daylight Saving Time is selected, the existing data will be displayed as "OLD_" in the search and log list.

6-1-4 Auto Reboot

Auto Reboot is for system stability, rebooting itself regularly.

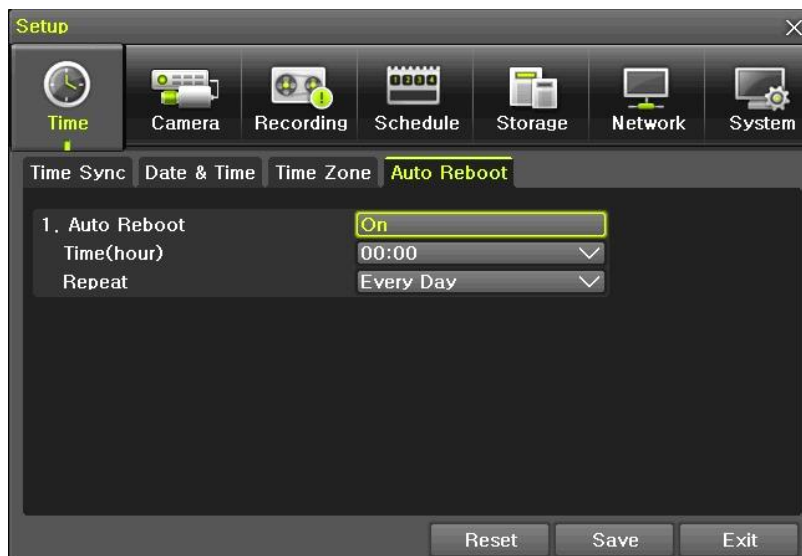

[Figure 6-44. Setup / Auto Reboot Menu]

6-2 Camera

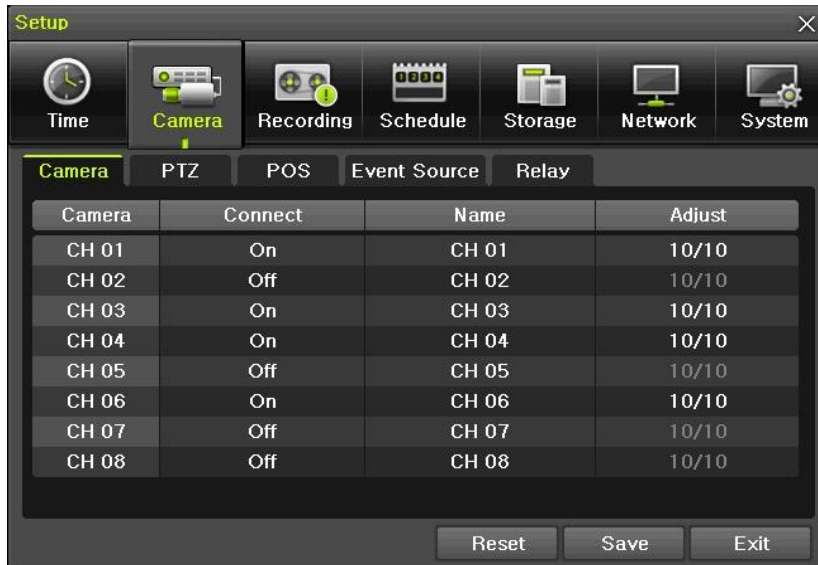

[Figure 6-45. Setup / Camera Menu]

6-2-1 Camera

① Connection

Used to set whether to connect or disconnect each camera channel.



※ When the camera channel is set to disconnected, the video contents will not be displayed even if the camera is actually connected.

② Title

Name each camera. Max. 20 letters are available.

③ Adjust

Adjust Brightness/Contrast/Color/Saturation/Sharpen/Camera.

6-2-2 PTZ

Setup the protocol and baud rate of the PTZ Camera.

6-2-3 POS

Setup the protocol and baud rate of the POS device.

6-2-4 Event Source

Select {Menu} → {Setup} → {Camera} → {Event Source}.

(1) Motion Area

The user can setup the motion detection area. Area setup related to motion can be decided.

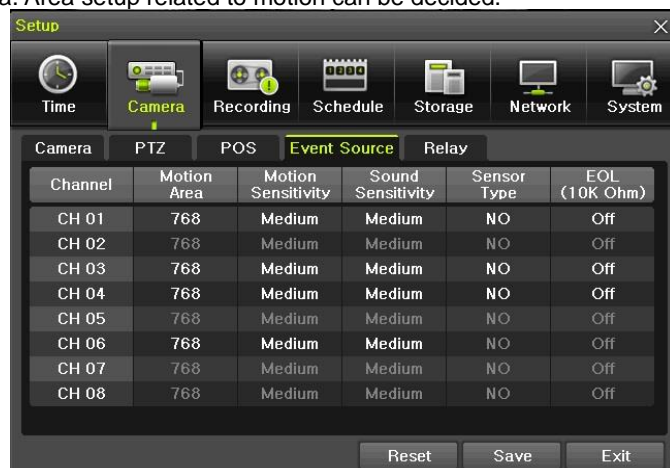
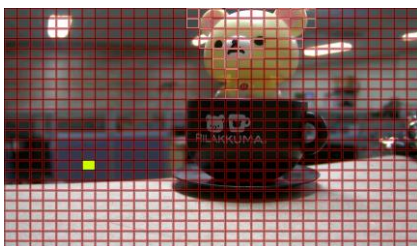

[Figure 6-46. Motion Area Setup]

- ① Select Motion Area of each channel.
- ② It becomes the 1 channel division mode and rectangular boxes appear where motions occur. Drag the yellow pixel cursor by using the mouse or the front button/remote controller and select pixels where motion detection doesn't apply. The selected area turns brown.
- ③ Select Exit to finish.

(2) **Motion Sensitivity** : Lowest/Low/Middle/High/Highest.

(3) **Sound Sensitivity** : Lowest/Low/Middle/High/Highest

(4) **Sensor Type** : Select the sensor type.

(5) **EOL** : EOL Function Select (On / Off).

6-2-5 Relay

Select the relay type.

6-3 Recording

The Main setup is to configure the environment of record and system and major functions. In the real-time monitoring, move to {Menu} → {Setup} → {Recording}

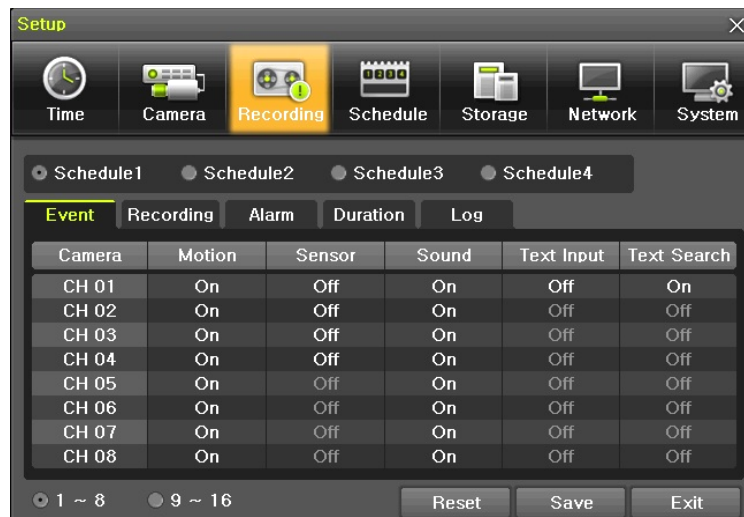

[Figure 6-47. Setup / Recording]

6-3-1 Schedule Selection (Schedule1 ~ Schedule4)

- ① Each channel can be scheduled in 4 different schedules. This schedule can be set as the recording schedule and each time can be 4 different schedules.

6-3-2 Event

This is to set the events On/Off of Motion / Sensor / Sound / Text Input / Text Search.

Recording Type	Description
Continuous	Continuous recording based on the Normal Speed frame rate.
Motion	When motion is detected, recording will be initiated based on the event frame rate.
Sensor	When input signal from an external sensor is generated, recording will be initiated based on the event frame value.
Sound	When audio is detected, recording will be initiated based on the event frame value.
Text Input	When a text is received from POS device, recording will be initiated based on the event frame value.
Text	When searching Text, can select to receive email regarding the 'Word' that is set..

Search	
--------	--

6-3-3 Recording

(1) Recording Resolution

Used to set the resolution of the recorded channel.

Type Resolution	Input Camera Type			
	1080P	720P	960H	
			NTSC	PAL
CIF	-	-	352 x 240	352 x 288
D1	-	-	704 x 480	704 x 576
960H	-	-	944 x 480	944 x 576
720P	1280 x 720	1280 x 720	-	-
1080P	1920 x 1080	-	-	-

(2) Recording Quality

Used to set the quality of the recorded video. Select among five levels {Lowest} / {Low} / {Middle} / {High} / {Highest}.

	※ The higher picture quality, the bigger file size.
---	---

(3) Frame Rate

If the user configures Normal Speed and Event Speed at the same time, the continuous recording follows Normal Speed frame rate and the event recording follows Event Speed frame rate.

Normal Speed	Set the recording frame rate for Continuous recording.
Event Speed	Set the recording frame rate for Motion, Sensor, Audio, Text

Resolution Model	Maximum Recording Frame by Resolution				
	1080P	720P	CIF (NTSC/PAL)	D1 (NTSC/PAL)	960H (NTSC/PAL)
16CH	480	480	480/400fps	480/400fps	960 /800fps
8CH	240	240	240/200fps	240/200fps	480/400fps
4CH	120	120	120/100fps	120/100fps	240/200fps

(4) Audio

Used to set the recording of the external audio input linked to the system.

6-3-4 Alarm

※ This function is used to generate alarms through the Buzzer / PTZ Preset / e-mail / Relay / Spot / Popup in case of an event. PTZ preset can be configured between 1-16.



※ Popup function is to inform event occurrence to the user through a warning window in the real-time monitoring mode.

6-3-5 Duration

Setup Pre-Recording(On / OFF), Post-Recording(5 / 10 / 15 / 20 / 60 / 150 / 300 seconds).

※ in Pre-Recording, images of the last 7 seconds before the event occurrence are recorded.

6-3-6 Log

Setup On / Off for Motion / Sensor / Sound / Text Input.

6-4 Schedule

H-model series provide 4 different recording mode configurations. Each schedule mode can be set one week/24 hours and the recording follows the setting automatically.

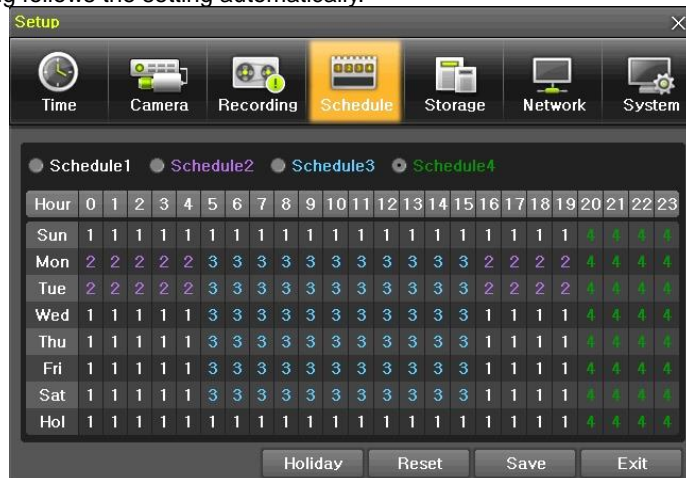

[Figure 6-48. Schedule Window]

6-4-1 Schedule Setup

Select one schedule among Schedule1, Schedule2, Schedule3 and Schedule4.

(1) Selection Tip

- ① Select the day and time to be set by using the arrow keys.
- ② Select after moving the cursor onto Time(0-23) or Day(Sun. – Holiday) then the user can configure the whole line at once.
- ③ Using the mouse can be easier.

(2) Holiday Registration

This feature is used to enable the user to set the holidays and schedule independently.

- ① Move to **{Schedule}** → **{Holiday}**.

	<ul style="list-style-type: none"> ※ If the date for the holiday and day of the week are the same in the {Schedule} menu, the holiday setup will have priority over the date setup. ※ Designated holidays are marked with a red tag.
--	---

- ② On the Holiday Registration Window, select the date by using the arrow keys and the Select button and press the Select button.
- ③ After setting the holiday, move to **{Save}** at the bottom of the menu. Afterward, press the Select button.

6-5 Storage



[Figure 6-49. Storage Window (Local)]



In the Storage menu, To apply the new setting, save the new setting after changing the setting.
Reset: Initialize the menu to the basic setting.

6-5-1 Max. Recording Days

This is to limit the recording days. You can set None/1day/7days/30days/User setting(1-31).

6-5-2 HDD Overwrite

- ① Select On/Off for HDD Overwrite.

On	If there is no more hard disk space left, the existing files will be overwritten by starting with the oldest.
Off	If there is no more hard disk space left, the further recording will not be executed.

6-5-3 Local Storage Management

(1) Local Storage Management Function

Local Storage refers to the internal hard disk and storages connected to the system via USB. Local Storage is classified and managed as **{Recording}**, **{Backup}**, **{New}**, **{iSCSI}** and functions are described below.

① Recording

The Recording storage is managed in Direct. The Recording storage stores data on the hard disk in the real time. Five commands can be executed. Depending on the S/W status, however, some commands cannot be executed.

New	Returns the status of the selected storage device to New; if this command is executed, the selected storage device will be moved to the {New} storage device manager.
------------	--



※ Physical states supporting the execution of the commands above includes Healthy and Warning. In fault state, however, no command can be executed.

② Backup

The backup storage is managed in Backup. Backup storages are not used to store data; rather, they are only used to back up the data. The user can execute only the **{New}** command.



Depending on the storage type, the storage is used only for (Recording) or (Backup) purposes.

③ New

All storages, initially detected are managed in **{New}**. All initially detected storages are displayed as New and can be changed into Recording storage or Backup Storage.

Recording-Format	Changes the selected storage into a dedicated recording storage.
Backup-Format	Changes the selected storage into a backup storage.



In **{New}**, At least, one storage shall be selected as a dedicated storage. Otherwise, the data cannot be stored in the real time.

(2) Composition of the local storage device

	※ There are three software status types.
Active	Connected to storage or backup device; currently saving the data.
Online	Only connected to storage or backup device.
Offline	Not connected to storage or backup device.

	※ There are three hardware status types.
Healthy	Connected to storage or backup device; functions normally.
Warning	Connected to storage or backup device, but error was detected; in this case, data storing or backup cannot be made (for more information, see the description below).
Fault	Not connected to storage or backup device; cannot perform data saving or backup.



1. **Fault State** : The storage device is completely damaged, and none of the S/W operations can be performed. The fault state is not related to a DVR problem. The DVR has detected the fault and stopped the recording.
2. **Warning State** : The storage device has a physical error that can be corrected by the storage device or by the DVR. If the error is not taken care of, however, the storage device is likely to be damaged (and shift to fault state). Backing up data in the corresponding storage device and replacing the device with a normal one are strongly recommended.
3. If there is an active storage device with a warning or a fault, a message is displayed on the upper left part of the screen.

(3) Instruction when adding the local storage device

- ① Open the system body and install a new disk (connect the data cable and the power cable)
- ② Connect power to the system and boot the system.
- ③ Select **{Menu}** → **{Setup}** → **{Storage}** by using the arrow keys and the Select button.
- ④ A newly displayed disk will then be displayed as **{New}**.
- ⑤ Select a newly installed disk by using the arrow keys and the Select button and initialize the disk as a **{Recording}** or a **{Backup}** disk. The following describes the method of setting the recording storage.
- ⑥ **{Recording}** shows the status of the newly installed disk online.



※ **Selecting {Recording-Format} or {Backup-Format} causes all data in the device to be erased. Therefore, caution is required.**

※ **While {Recording-Format} or {Backup-Format} is being set up, do not remove the device (may cause an error when detecting the device).**

※ **To use the external or portable storage device for system upgrade, set to {Backup-Init} in the {New} item for {Main Setup} {Storage Device} {Local Storage Device Management}.**

※ **When used in DVR equipment for the first time, a backup USB device will always be detected in the {New} category. Therefore, a USB device in the {New} category must be set up as {Backup-Format} prior to use for backup. A USB device that has gone through this procedure will be detected in the {Backup} category when used again in the DVR equipment.**

(1) How to changed FAULT HDD

- ① Check Faulty HDD number
- ② Turn OFF unit by power button.
- ③ Detach cover of DVR
- ④ Find the faulty HDD by number printed on mainboard
- ⑤ Detach the faulty HDD
- ⑥ Attach new HDD.
- ⑦ Attach cover of DVR

(2) HDD Format for Recording

Select the model first.

As shown below, proceed with the following order {New} → {Recording-Format}.

6-6 Network

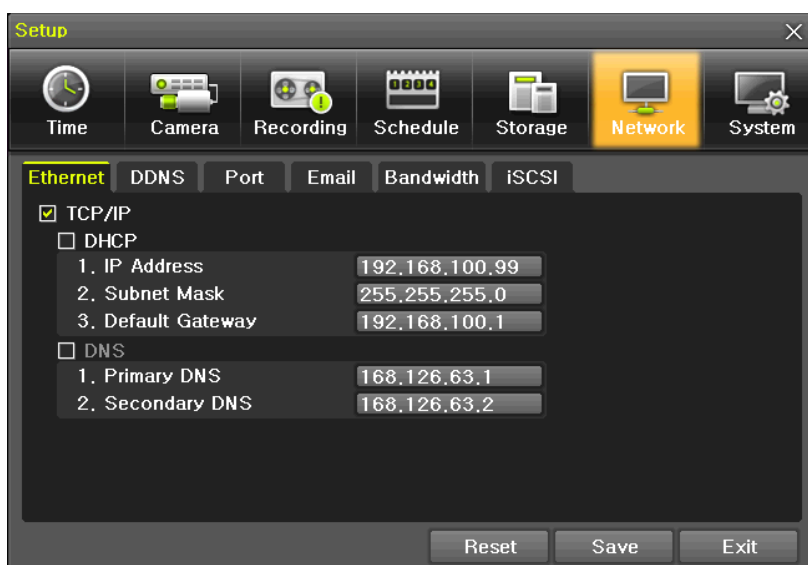

[Figure 6-50. Setup Network Window]

6-6-1 Ethernet

(1) TCP/IP

This is to use a fixed IP in the Local Area Network environment.

- ① Select {Ethernet} in {Menu} → {Setup} → {Network}.
- ② Select {TCP/IP}.
- ③ Save after filling in IP Address, Subnet Mask, Default Gateway, Primary DNS, and Secondary DNS.

6-6-2 DDNS

As part of the DNS system, the Dynamic Domain Name System (**DDNS**) service updates IP addresses of the host name in the real time and allocates fixed domain names to systems linked to dynamic IP addresses to allow users to use the same DNS name regardless of the change of in the IP address.

It provides dynamic DNS to ensure URL access in the dynamic IP environment.

User can monitor the remote place thru internet with web server functions which is equipped in DVR.

- ① Select On/Off of DDNS or a domain name to use by using arrow keys and the selection button.
- ② In case of DDNS On, enter the host name and save it then, the registration procedure of the host name proceeds automatically. You can enter the host name with 4-20 letters.
- ③ The host name to enter must not be pre-registered in DDNS sever. Otherwise it won't work.
- ④ The basic host name is the MAC address of appertaining DVR.
- ⑤ In case the host name have entered starts with "000c28", none of MAC address will work excepting for appertaining DVR's.
- ⑥ In case of DynDNS On, enter the host name, user name registered in DynDNS and password then, save them.



- ※ Access to DynDDNS sever(<http://www.dyndns.org>) and apply for the user account then, register the domain name to use and enter URL.
- ※ For more information, please access to the site.

6-6-3 Port

Move to {Menu} → {Setup} → {Network} → {Port}.

This feature is used to set the network port.

The default value is 50100; a randomly chosen value can be used depending on the network environment. The Web Server Port is used to connect the DVR remote monitoring. The Web Port Default is 80, but can be set between 2000 ~ 65527.

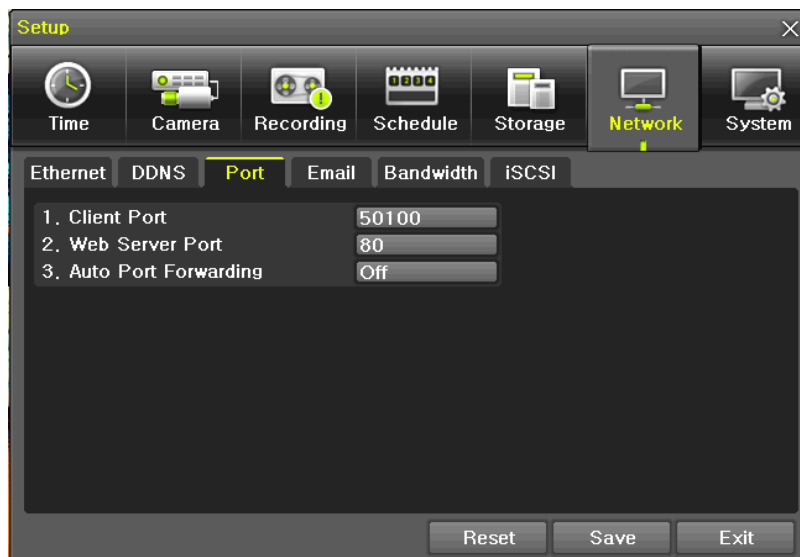

[Figure 6-51. Network Port Window]

6-6-4 E-mail

- ① Move to {Menu} → {Setup} → {Network} → {E-mail}. To use the e-mail function, DNS or sub DNS in {Menu} → {Setup} → {Network} → {Ethernet} need to be configured.

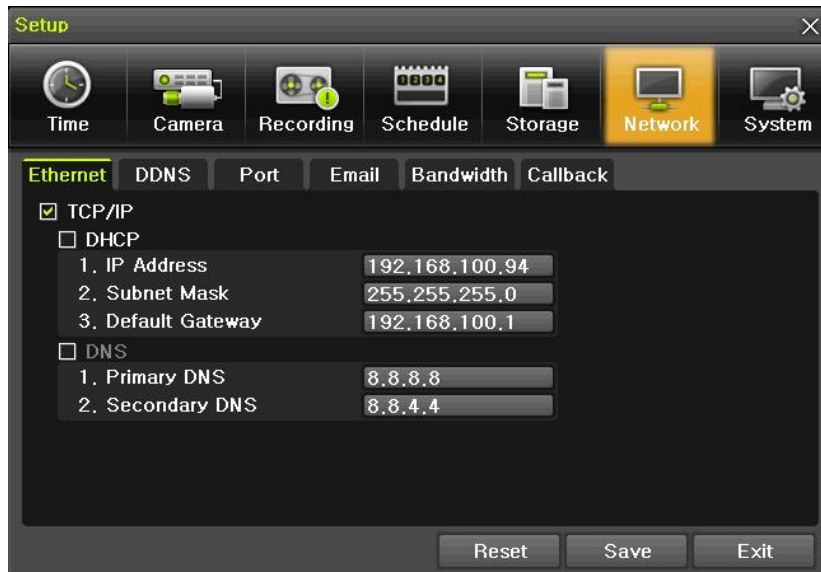

[Figure 6-52. Setup Network Ethernet Window]

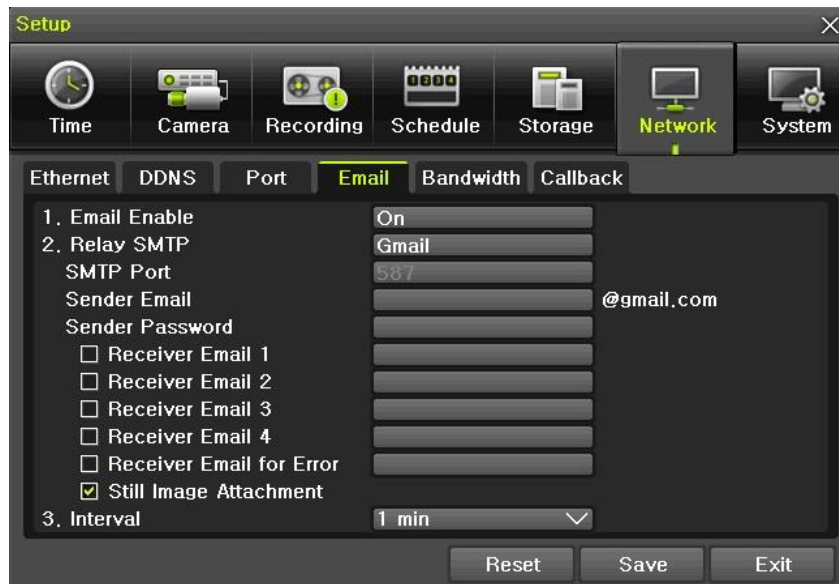

[Figure 6-53. Setup Network E-Mail Window1]

This is to set automatic E-mail transmission service when an event occurs.

To use the e-mail function, {E-mail} in {Menu} → {Setup} → {System} → {9. Alarm} or {E-mail} in {Menu} → {Setup} → {Action} → {Alarm} need to be configured.

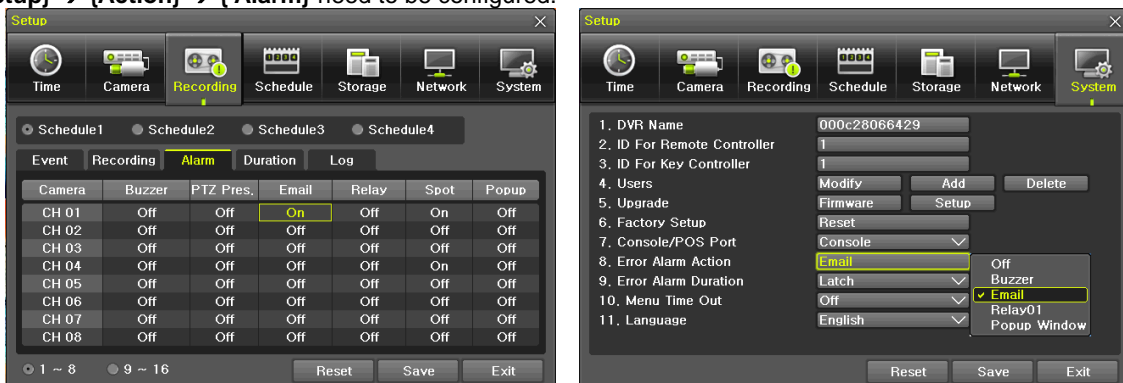

[Figure 6-54. Setup Network E-Mail Window2]

- ② Relay SMTP is set on 'Gmail' as default, but when 'Default' (in menu tab) is selected, this will be changed to dvr@cctvuser.com.
- ③ Receiver Email can be set up to 5 users (emails).
- ④ Email Interval settings are as follows [5 sec / 1 min / 3 min / 5 min /10 min].

6-6-5 Bandwidth

Move to {Menu} → {Setup} → {Network} → {Bandwidth}.

This sets up the limit of the bandwidth to be used when bringing the live image, adjust resolution/quality and transmitting the data by using the network.

Image Resolution	CIF / D1 / 960H
Image Quality	Adjust quality of the image, as the value increases, the compression rate gets higher and image quality gets low. However the transmission rate gets higher.
Bandwidth Limit	You can set the network bandwidth between 40 ~ 4000kbps. As the value increases, the network transmission speed gets faster. Select Off if you do not wish to limit the network bandwidth.
Transmission Codec	JPEG / H.264

6-7 System

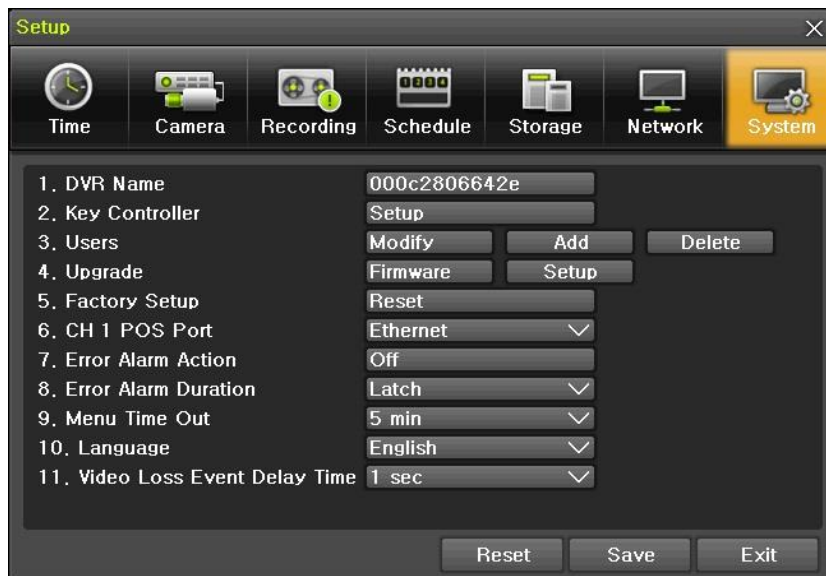

[Figure 6-55. System Setup Window]

1. DVR Name	Used to name the DVR device.
2. ID For Remote Controller	Used to name the remote controller for running the system.
3. ID For Key Controller	Unique system controller number setting.
4. User Registration	Used to register, add, or delete users.
5. Admin. Password	Used to set the password of the Local System Administrator.
6. Upgrade	Upgrades the system firmware/system setup
7. Factory Setup	Initialize Setup.(Factory default value, except for the network value)
8. POS	Set Ethernet POS or RS232
9. Alarm	Set the alarm On/Off and alarm format.
10. Alarm Duration	Set the alarm time by continuous/5/10/15/User setting
11. Menu Time Out	Used to set the time for exiting the System Setup menu automatically and displaying the real-time monitoring screen.
12. Language	System OSD language setting
13. Video Loss Event Delay Time	It keeps 'Video Loos' during the setting period, then Video Loss event comes out (You can set Video Loss Event duration time with 1/2/3/4/5 Sec)

6-7-1 DVR Name



. The initial value is the Mac address. (It supports up to 20 letters for the system name.)

6-7-2 ID for Remote Controller

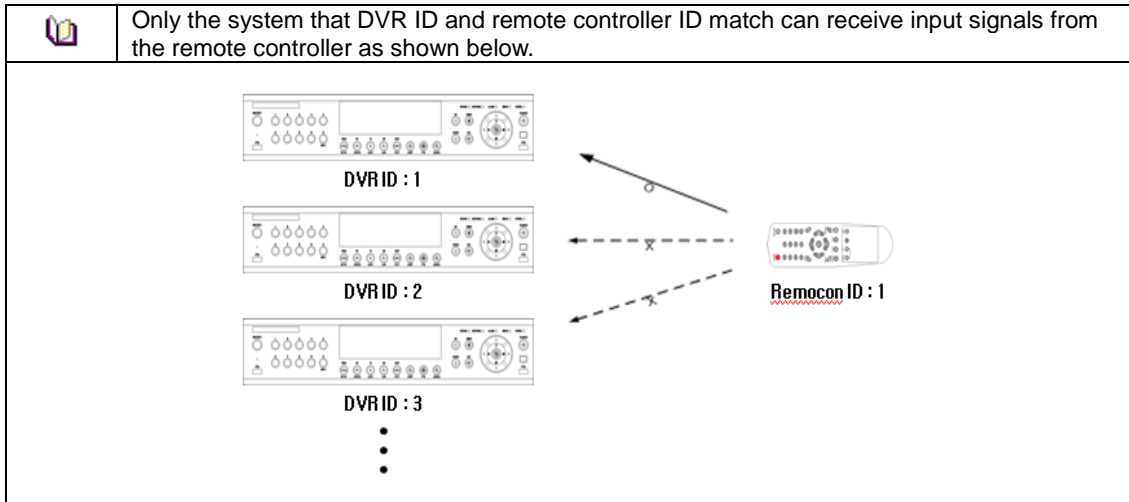
When multiple devices are used, set the remote controller ID to identify input signals from the remote controller.



- ① Move to {Menu} → {Setup} → {System} → {2. Remote Controller ID}.
- ② In the selection window, enter ID by using the arrow keys and the Select button (the number 0~99 is available for ID.)

	If you forget the DVR ID, set the remote controller ID to 999 to start the DVR. Note, however, that the DVR ID should be the same as the remote controller ID.
	<p>※ To configure Remote Controller ID (Example: ID setting as 3)</p> <ol style="list-style-type: none"> 1) Press {ID} button on the remote controller. 2) Press the {0} key and {3} key. 3) Press {ID} button again. 4) Remote Controller ID is set as 3.

6-7-3 ID For Keyboard Controller

- ③ Move to {Menu} → {Setup} → {System} → → {3. ID for Key Controller}.
- ④ In the selection window, enter ID by using the arrow keys and the Select button (number 1~255 is available for ID.)

6-7-4 User Registration

※ Add, edit, or delete the users who will operate the system and give authorities to users as shown below.

System Access Authorization	
Network Live	View the real-time images upon network access.
Playback	View the recorded images.
Copy (download)	Copy and download files.
PTZ camera	PTZ camera control
Setup	Recording, schedule, system, storage, Time, PTZ, network, Screen setup
Network Upgrade	Remote network upgrade
Covert channel monitoring	View the covert channel in the network.



Up to 15 users can be registered. Letters for ID and Password can be entered up to 30.

6-7-5 Admin. Password

Setup the Administrator Password. The password can hold up to five digits.

6-7-6 Upgrade

The firmware and menu setting of the product can be easily upgraded through the use of the external storage devices or portable storage devices with USB 2.0 port.

※ Find and copy the upgrade file to the highest folder in the external storage device or portable storage device supporting USB 2.0.

※ Connect the storage device with an upgrade file stored to USB 2.0 port at Right front panel.

	<ol style="list-style-type: none"> 1) After copying the upgrade file, be advised to get rid of the USB device with safety removal mode from PC. 2) If the USB device is disconnected from the USB port while the upgrade file is being copied, the DVR system may not automatically detect the file.
---	--

 Caution	<p>Removing USB during the upgrade in progress may cause damage on the system.</p> <p>The system starts over when the upgrade is completed.</p>
--	---

(2) Firmware Upgrade

① Select **{Firmware}** and the upgrade file list stored in the selected device and simple version info of the selected file are then displayed. Select a file and Firmware Upgrade window appears.

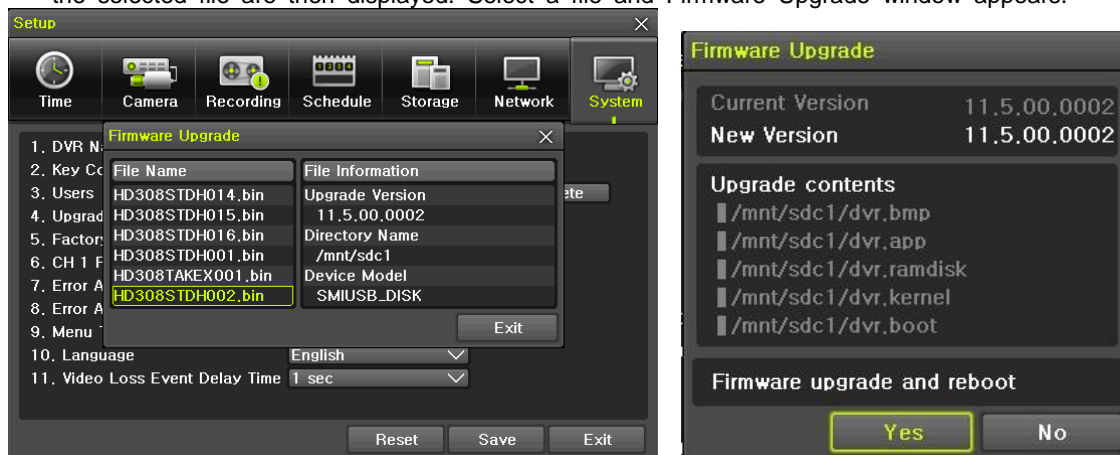

[Figure 6-56. Firmware Upgrade Progressing Window]

	<ul style="list-style-type: none"> ※ Downgrading to a previous version is not supported. ※ The upgrade information window will then appear within 15 seconds.
---	---

② Read the information and select {Yes} to start the upgrade gradually. Select {No} to return to the **{System}** mode.

③ After the upgrade is completed, the system reboots.

④ Move to **{Menu}** → **{Miscellaneous}** → **{DVR Information}** → **{3. Software Version}** to check the version.

(3) Setup Upgrade

① Select **{Setup}** and the upgrade file list stored in the selected device and simple version info of the selected file are then displayed.

② Select a file and then the upgrade starts immediately.

 Caution	<p>Select a file and then the upgrade starts immediately. All setting values of the current menu will be changed to the upgrade setting values.</p>
--	---

6-7-7 Factory Default

- ① Move to {Menu} → {Setup} → {System} → {7. Factory Setup}.
- ② Select {Yes} when Initialization (Yes/No) Window appears.

 Caution	Note that all setting data will be initialized. ※ All values go back to Factory Default Value.
--	---

6-7-8 Console / POS Port

- ① Move to {Menu} → {Setup} → {System} → {8 Console / POS Port}.
- ② On the selection window, select the device by using the arrow keys and the Select button.

6-7-9 Alarm

Alarm is to notify system incidents [Video Signal loss/ HDD full/ FAN fail/ HDD fail/ HDD warning] through [Buzzer/ E-mail/ Relay01/ System check].

Select each [Off/Buzzer/E-mail/Relay01/Popup Window] by ticking.

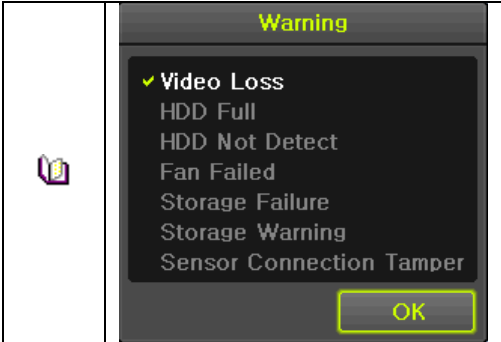
	※ Popup Window Setup at {Menu} → {Setup} → {System} → {9. Alarm}. Popup Window is to pop up the system check window in the monitoring screen as shown. it indicates [Video Signal loss/ HDD full/ HDD Not Detect / FAN fail/ Storage Fail/ Storage Warning / Sensor Connection Tamper].
--	---

6-7-10 Alarm Duration

- ① It sets the duration of the alarm triggered by the recording and system event.
- ② Move to {Menu} → {Setup} → {System} → {10. Alarm Duration}.
- ③ In the selection window, set Alarm Duration by using the arrow keys and the Select button.

6-7-11 Menu Time Out

If no input is made in the System Setup menu from the front buttons, remote controller and mouse, the system automatically shifts to the real-time monitoring mode.

- ① Move to {Menu} → {Setup} → {System} → {11. Menu time Out}.
- ② In the selection window, select the time zone you want to set by using the arrow keys and the select button.

Off	The Automatic Menu Exit is not used. ※ The user can exit the menu by pressing the [ESC] button in the System menu.
1/2/3 MIN	If there is no input from the front button, remote controller, or mouse, the system will shift to the real-time monitoring mode.
User Setting	The user can enter the time directly. ※ The time can be set to 1 ~ 60 minutes.

- ③ Selecting the User Setting causes the input window to appear.
- ④ Enter the time by using the numeric buttons or the arrow keys and the Select button.

6-7-12 Language

This feature is used to select the language for the On Screen Display (OSD) menu of the system. 18 languages are supported.

APPENDIX

A/P/P/E/N/D/I/X

Recommended PTZ Camera Protocol

NO	Vendor	Model	Protocol
1	A.D.	ULTRA_7	SENSORMATIC
		ULTRA_8	
2	CHOU	COHU3925	COHU
3	Dongyang	Dongyang	DRX-500
			DY-255
4	DYNACOLOR	DSCP	DSCP
5	EYE VIEW	EYE VIEW	EYE VIEW
6	FINE SYSTEM	CRR-1600i/s	CRR-1600i/s
7	GE	GE	GE_KARATEL
8	GSP	GSP	CYBERSCAN_1
9	HITRON	FASTRAX2	FASTRAX2
10	HONEYWELL	SCANDOME2	HSDN-251
11	LG	LG	LG_MULTIX,
			LG_OLD
12	MIKAMI	MIKAMI	MIKAMI
13	ORIENTAL	ORX-1000	ORX-1000
14	PANASONIC	WVCS854	WVCS854
15	PELCO	PELCO	PELCO - D
			PELCO - P
16	PHILIPS	PHILIPS	PHILIPS
17	PROLINE	PROLINE	PROLINE_UK
18	RIFATRON	RIFATRON-1	RIFATRON
19	SAMSUNG TECHWIN	SAMSUNG	SPD-1600
			SCC641
20	SUNJIN	SUNJIN	SUNJIN
21	VICON	VICON	VICON
22	YOKO	YOKO	YOKO